

RoHS

This products can apply to the SESO Doc NO. QA-3-04-005 of Environmental&Material Management Rules

■ Specifications :

- Voltage rating: 250V AC / DC
- Current rating: 3A AC / DC
- Withstanding voltage: 1000V AC/minute
- Temperature range: -40°C~+105°C
- Insulation resistance:≥1000MΩ
- Contact resistance: ≤10mΩ
- After environmental testing: ≤20mΩ
- Suitable SESO Terminal:2508T
- Mates With SESO Wafer:2508W

2508 H X XX X-N0 XX - X
① ② ③ ④ ⑤ ⑥ ⑦ ⑧

① Series No.

② Category: H-HSG

③ Appearance type: Blank-ordinary

④ Row No.-Pin No.: XX-Single Row

⑤ Special No.: Blank-Ordinary

B-Special Packing

⑥ Material : N0-PA66 94V-0

⑦ Color: Blank-Natural Color

⑧ C- The glow-wire test of 750°C 

Poles	Dimensions (mm)		
	A	B	C
02	2.50	7.30	5.65
03	5.00	9.80	8.15
04	7.50	12.30	10.65
05	10.00	14.80	13.15
06	12.50	17.30	15.65
07	15.00	19.80	18.15
08	17.50	22.30	20.65
09	20.00	24.80	23.15
10	22.50	27.30	25.65
11	25.00	29.80	28.15
12	27.50	32.30	30.65
13	30.00	34.80	33.15
14	32.50	37.30	35.65
15	35.00	39.80	38.15

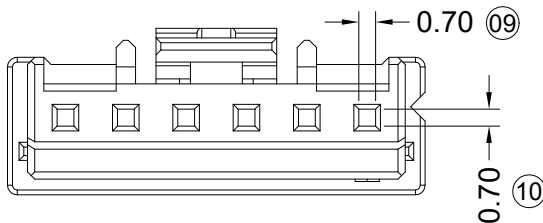
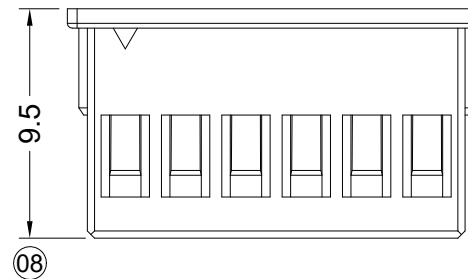
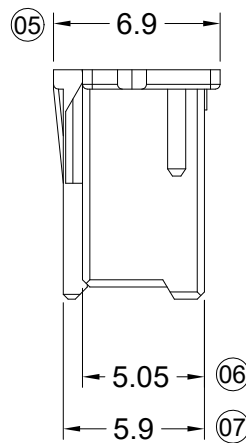
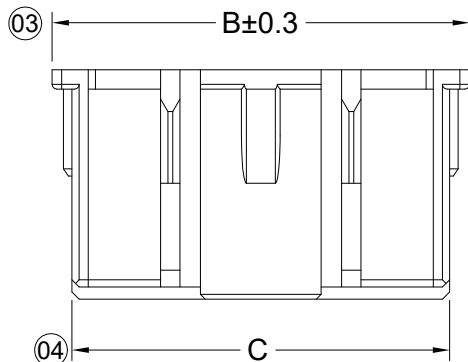
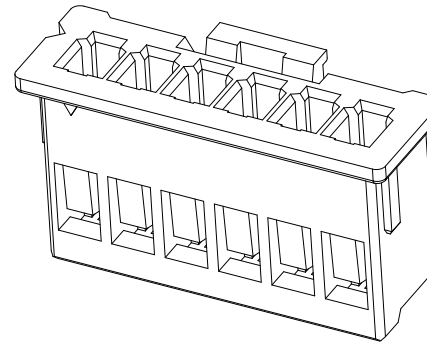
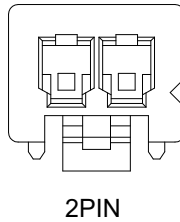
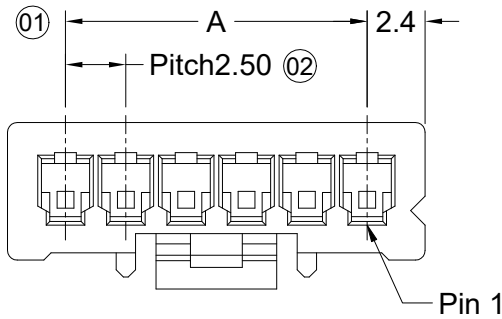

2021/05/06	C	EN120210506001	Add new product type	TengMin	John Yang
2020/03/31	B	EN20200331001	Update Drawing Frame	Zeng	Robing
2017/08/11	A	/	Initial release	Alan qin	Guo
DATE	REV	ECN NO.	DESCRIPTION	MODIFY	APPROVAL

GENERAL TOLERANCE	
.X	±0.30
.XX	±0.20
.XXX	±0.10
X.°	±2°
PROJECT	

SMS 东莞市思索技术股份有限公司
 Dongguan SESO Technology Co.,Ltd.

APPROVAL	CHECK	DRAWN	DATE
Smark	Guo	Alan qin	2017/08/11

PART NO. 2508H-XXX-N0-X				
TITLE 2.50 mm Crimp Style connectors				
UNIT	SCALE	SHEET	REV	NUMBER
mm	1:1	1/3	C	A-022

F
E
D
C
B
A

F
E
D
C
B
A

1 2 3 4 5 6 7 8

RoHS

This products can apply to the SESO Doc NO. QA-3-04-005 of Environmental&Material Management Rules

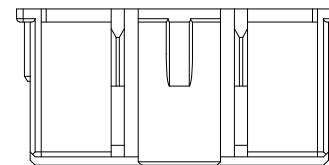
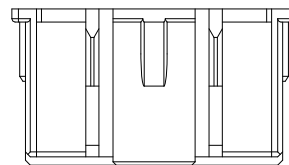
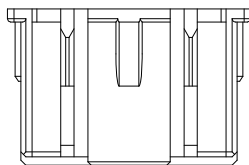
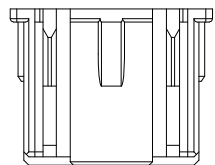
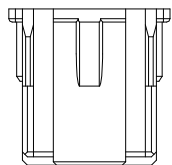
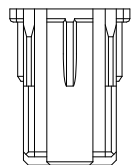
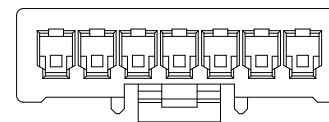
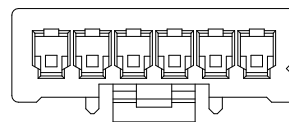
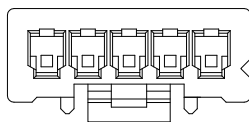
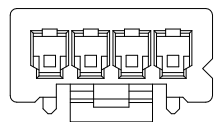
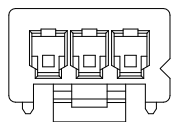
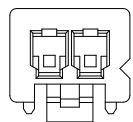

2PIN

3PIN

4PIN

5PIN

6PIN

7PIN

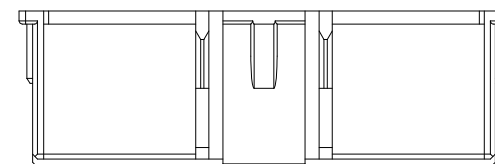
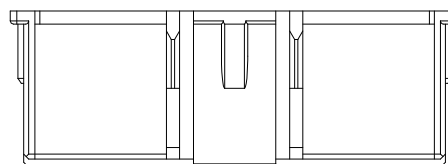
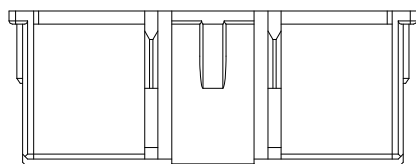
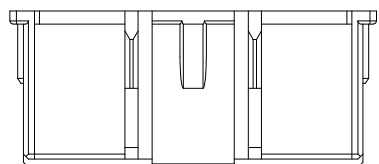
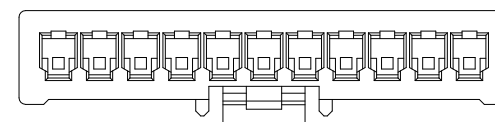
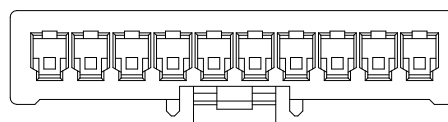
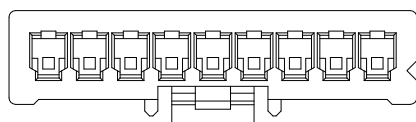
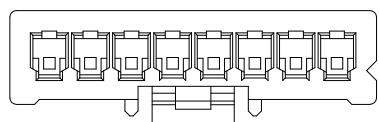

8PIN

9PIN

10PIN

11PIN

2021/05/06	C	EN120210506001	Add new product type	TengMin	John Yang	GENERAL TOLERANCE .X ±0.30 .XX ±0.20 .XXX ±0.10 X.° ±2° PROJECT 	SMS 东莞市思索技术股份有限公司 Dongguan SESO Technology Co.,Ltd.				PART NO. 2508H-XXX-N0-X					
2020/03/31	B	EN20200331001	Update Drawing Frame	Zeng	Robing						APPROVAL CHECK DRAWN DATE Smark Guo Alan qin 2017/08/11				TITLE 2.50 mm Crimp Style connectors	
2017/08/11	A	/	Initial release	Alan qin	Guo							UNIT	SCALE	SHEET	REV	NUMBER
DATE	REV	ECN NO.	DESCRIPTION	MODIFY	APPROVAL							mm	1:1	2/3	C	A-022

RoHS

This products can apply to the SESO Doc NO. QA-3-04-005 of Environmental&Material Management Rules

F

F

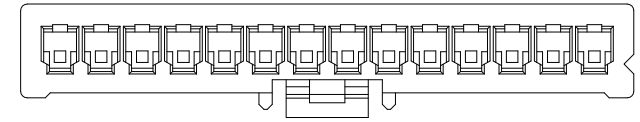
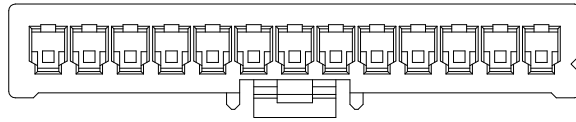
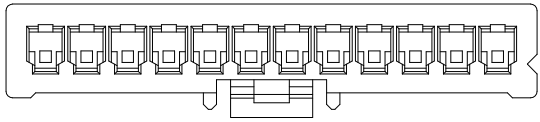

E

E

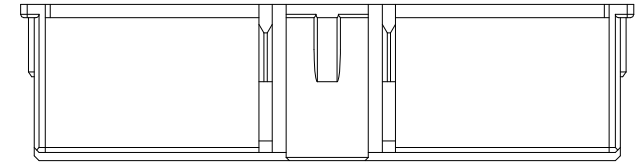
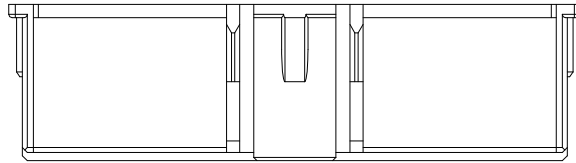
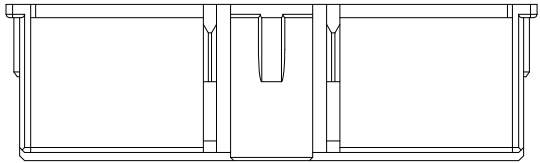

D

D

12PIN

13PIN

14PIN

C

C

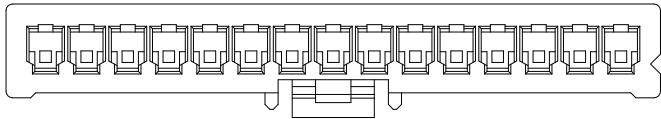

B

B

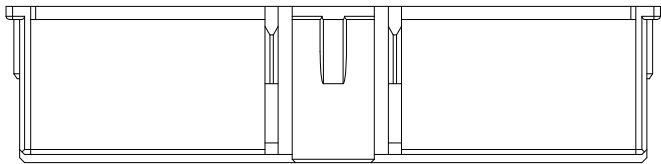

15PIN



A	2021/05/06	C	EN120210506001	Add new product type	TengMin	John Yang	 东莞市思索技术股份有限公司 Dongguan SESO Technology Co.,Ltd.				PART NO. 2508H-XXX-N0-X					
	2020/03/31	B	EN20200331001	Update Drawing Frame	Zeng	Robing					TITLE 2.50 mm Crimp Style connectors					
	2017/08/11	A	/	Initial release	Alan qin	Guo					APPROVAL	CHECK	DRAWN	DATE	UNIT SCALE SHEET REV NUMBER	
	DATE	REV	ECN NO.	DESCRIPTION	MODIFY	APPROVAL					Smark	Guo	Alan qin	2017/08/11	mm	1:1

A

1 2 3 4 5 6 7 8

RoHS

This products can apply to the SESO Doc NO. QA-3-04-005 of Environmental&Material Management Rules

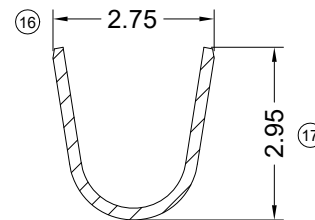
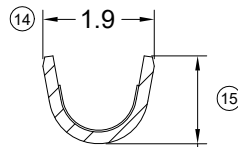
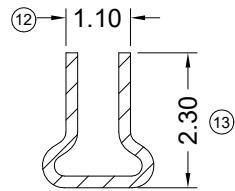
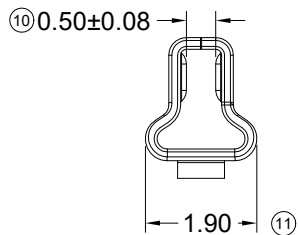
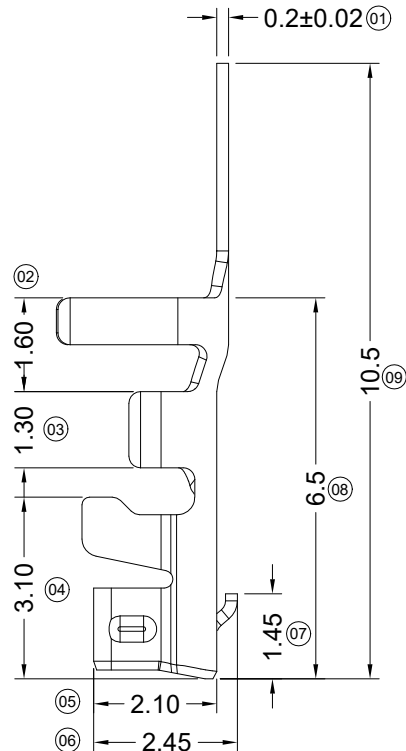
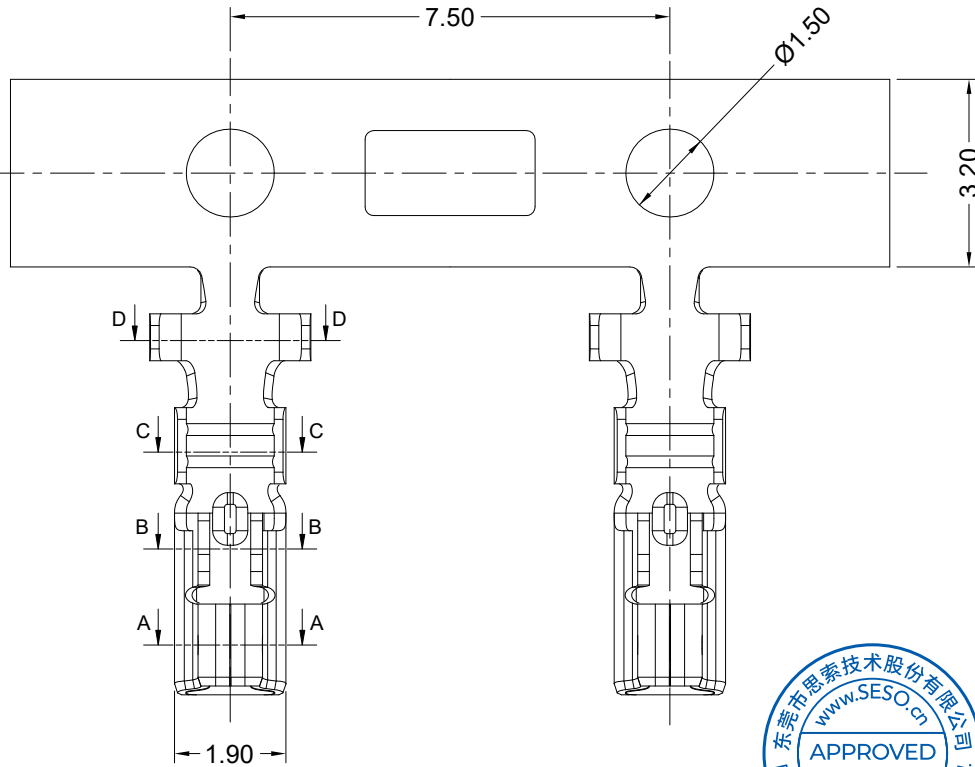

- Specifications
- Voltage rating: 250V AC / DC
- Current rating:
- AWG22#:3A AC / DC
- AWG24#~26#:2A AC / DC
- Withstanding voltage: 1000V AC/minute
- Temperature range: -40°C~+105°C
- Insulation resistance: ≥1000MΩ
- Contact resistance: ≤10mΩ
- After environmental testing: ≤20mΩ
- Wire Size:AWG#22~26(0.35~0.13mm²)
- Insulation O.D.:1.60mm (Max)
- Mates with SESO Housing: 2508H

2508 T X-P XXX X-X
① ② ③ ④ ⑤ ⑥ ⑦

- ① Series No.
- ② Category:T-Terminal
- ③ Shape:Blank-ordinary
- ④ Material:P-Phosphor bronze
- ⑤ Plating Style:
SN1-Underplate:Ni 40~120u" (1~3um) overall
Top plating:Sn 80~200u"(2~5um) overall;
V05-Gold 5u" Min. ,Ni: 50u" Min. ⚠
- ⑥ Plating Method:
Blank-Stamping before plating
- ⑦ Mold No./Mark/Special No.

A	2023/2/2	C1	/	Added gold plated 5u" specification	Sunny Huang	Larry Yang	SMS 东莞市思索技术股份有限公司 Dongguan SESO Technology Co.,Ltd.	PART NO. 2508T-PXXX				
	2021/03/23	C	ER20210323001	Add current information	Wang	John Yang		TITLE 2.50 mm Crimp Style connectors				
	2020/03/31	B	EN20200331001	Update Drawing Frame	Zeng	Robing		APPROVAL	CHECK	DRAWN	DATE	
	DATE	REV	ECN NO.	DESCRIPTION	MODIFY	APPROVAL		Smark	Guo	Alan qin	2017/06/23	
							PROJECT	UNIT	SCALE	SHEET	REV	NUMBER
								mm	8:1	1/1	C1	A-000

RoHS

This products can apply to the SESO Doc NO. QA-3-04-005 of Environmental&Material Management Rules

Specifications :

- Voltage rating: 250V AC / DC
- Current rating: 3A AC / DC
- Withstanding voltage:1000V AC/minute
- Temperature range: -40°C~+105°C
- Insulation resistance:≥1000MΩ
- Contact resistance: ≤10mΩ
- After environmental testing: ≤20mΩ
- Material(Pin):Brass
- Mates With SESO Housing:2508H

2508 W V X-XX XX- N0 XX XX X
 ①① ①② ①③ ①④ ①⑤ ①⑥ ①⑦ ①⑧ ①⑨ ①⑩

- ① Series No.
- ② Category: W-WAFER
- ③ Connector Type: V-Straight 180°
- ④ Mounting Type: Blank-DIP
- ⑤ Row No.-Pin No.: XX-02P~15P
- ⑥ Special No.:
 Blank-Without a Post、With Kink
 N1-Without a Post、Without Kink
 P- With a Post、With Kink
 P1-With a Post、Without Kink
 P2-With a Post、Without Kink,DIP=4.5mm Δ
 N2-Without a Post、Without Kink,DIP=2.4mm
 N3-Without a Post、Without Kink,DIP=4.5mm Δ
- ⑦ Material: N0-PA66 94V-0
- ⑧ Plating Code: SN-Bright Tin Plating ;
 V05-Gold 5u" Min. ,Ni: 50u" Min. Δ
- ⑨ Color : Blank-Natural Color
- ⑩ Packing : Blank-PE Bag、T-Tray、C:With Cap

Poles	Dimensions (mm)		Poles	Dimensions (mm)	
	A	B		A	B
02	2.50	7.50	09	20.00	25.00
03	5.00	10.00	10	22.50	27.50
04	7.50	12.50	11	25.00	30.00
05	10.00	15.00	12	27.50	32.50
06	12.50	17.50	13	30.00	35.00
07	15.00	20.00	14	32.50	37.50
08	17.50	22.50	15	35.00	40.00

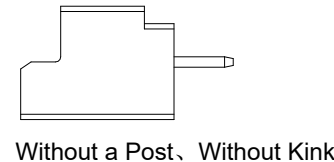
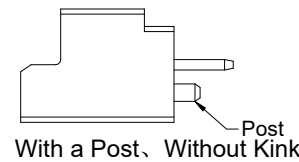
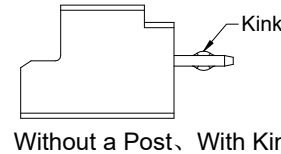
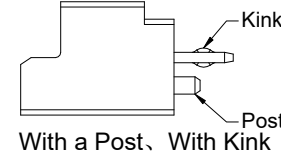
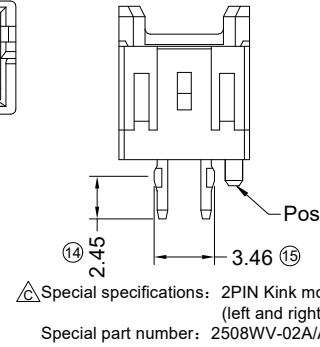
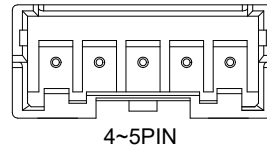
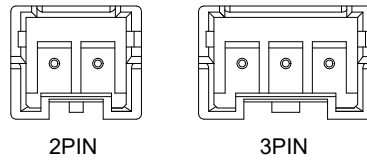
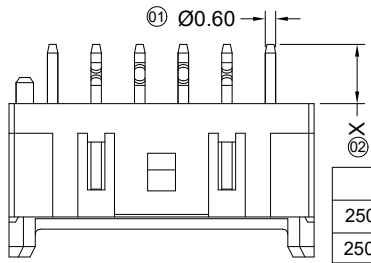

Item number	X value
2508WV-XX-XXXX	3.4mm
2508WV-XXP-XXXX	3.4mm
2508WV-XXP1-XXXX	3.4mm
2508WV-XXP2-XXXX	4.5mm
2508WV-XXN1-XXXX	3.4mm
2508WV-XXN2-XXXX	2.4mm
2508WV-XXN3-XXXX	4.5mm

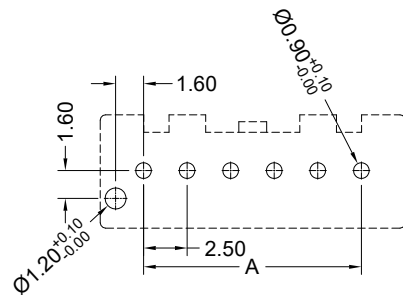
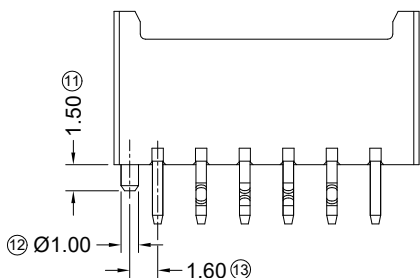
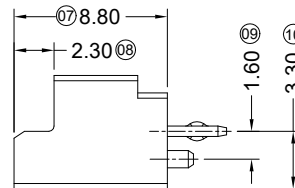
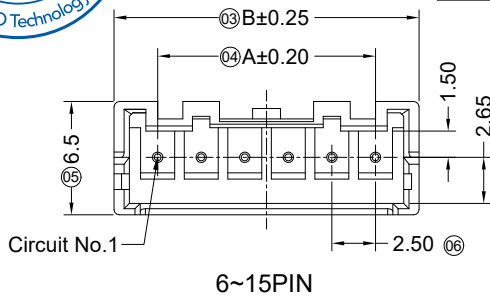

RECOMMENDED P.C.B LAYOUT (TOLERANCE:±0.05)



DATE	REV	ECN NO	DESCRIPTION	MODIFY	APPROVAL
2023/9/19	D3	/	Add encoding and description for P2 and N3	Larry Lin	Jack Zhang
2023/2/2	D2	/	Added gold plated 5u" specification	Sunny Huang	Larry Yang
2022/11/15	D1	/	New Specifications	Zeng	Larry

GENERAL TOLERANCE	
.X	±0.30
.XX	±0.20
.XXX	±0.10
X.°	±2°
PROJECT	
①	②

SMS 东莞市思索技术股份有限公司
 Dongguan SESO Technology Co.,Ltd.

APPROVAL	CHECK	DRAWN	DATE
Jack Zhang	Larry Yang	Alan qin	2017/11/21

PART NO.				
2508WV-XXXX-N0XXXX				
TITLE				
2.50 mm Crimp Style connectors				
UNIT	SCALE	SHEET	REV	NUMBER
mm	1:1	1/2	D3	A-000

RoHS

This products can apply to the SESO Doc NO. QA-3-04-005 of Environmental&Material Management Rules

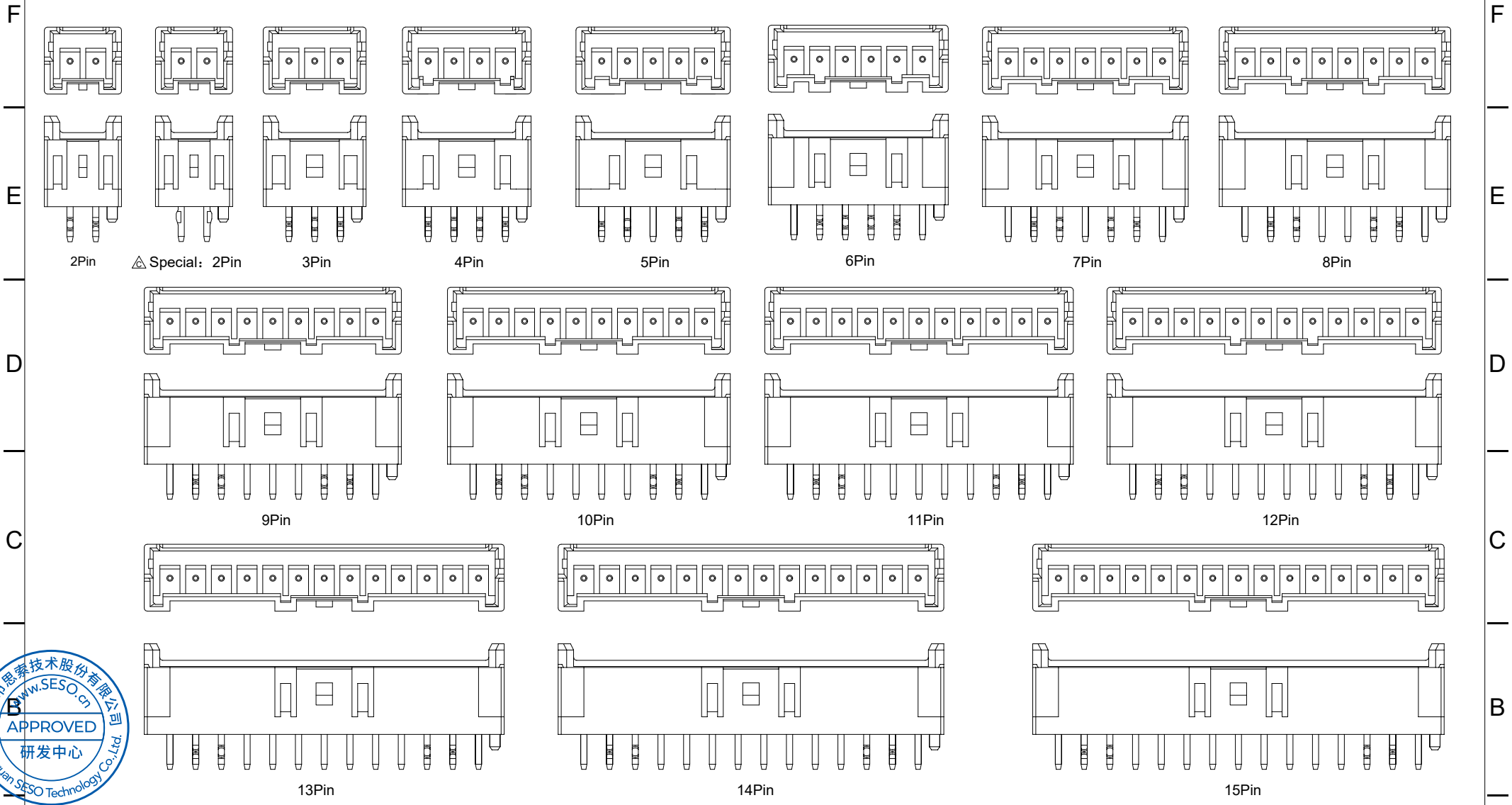

2023/9/19	D3	/	Add encoding and description for P2 and N3	Larry Lin	Jack Zhang
2023/2/2	D2	/	Added gold plated 5u" specification	Sunny Huang	Larry Yang
2022/11/15	D1	/	New Specifications	Zeng	Larry
DATE	REV	ECN NO	DESCRIPTION	MODIFY	APPROVAL

GENERAL TOLERANCE	
.X	±0.30
.XX	±0.20
.XXX	±0.10
X.°	±2°
PROJECT	

SMS 东莞市思索技术股份有限公司
Dongguan SESO Technology Co.,Ltd.

APPROVAL	CHECK	DRAWN	DATE
Jack Zhang	Larry Yang	Alan qin	2017/11/21

PART NO. 2508WV-XXXX-N0XXXX				
TITLE 2.50 mm Crimp Style connectors				
UNIT	SCALE	SHEET	REV	NUMBER
mm	1:1	2/2	D3	A-000

1 | 2 | 3 | 4 | 5 | 6 | 7 | 8

RoHS

This products can apply to the SESO Doc NO. QA-3-04-005 of Environmental&Material Management Rules

Specifications :

- Voltage rating: 250V AC / DC
- Current rating: 3A AC / DC
- Withstanding voltage:1000V AC/minute
- Temperature range: -40°C~+125°C
- Insulation resistance:≥1000MΩ
- Contact resistance: ≤10mΩ
- After environmental testing: ≤20mΩ
- Material(Pin):Brass
- Mates With SESO Housing:2508H

2508 W V X-XX XX- XX XX XX X
 ① ② ③ ④ ⑤ ⑥ ⑦ ⑧ ⑨ ⑩

- ① Series No.
- ② Category:W-WAFER
- ③ Welding Board Angle: V-Straight 180°
- ④ Welding Way: Blank-DIP
- ⑤ Row No.-Pin No.: XX-02P~15P
- ⑥ Special No.:
 Blank-Without a boss、With Kink
 N1-Without a boss、Without Kink
 P- With a boss、With Kink
 P1-With a boss、Without Kink
 P2-With a Post、Without Kink,DIP=4.5mm
 N2-Without a Post、Without Kink,DIP=2.4mm
 N3-Without a Post、Without Kink,DIP=4.5mm
- ⑦ Material: 9T-PA9T 94V-0
- ⑧ Plating Category: SN-Bright Tin Plating
 V01-Gold Flash
- ⑨ Color : Blank-Natural Color
- ⑩ Packing : Blank-Bag T-Tray C-Reel(With CAP)

Poles	Dimensions (mm)		Poles	Dimensions (mm)	
	A	B		A	B
02	2.50	7.50	09	20.00	25.00
03	5.00	10.00	10	22.50	27.50
04	7.50	12.50	11	25.00	30.00
05	10.00	15.00	12	27.50	32.50
06	12.50	17.50	13	30.00	35.00
07	15.00	20.00	14	32.50	37.50
08	17.50	22.50	15	35.00	40.00

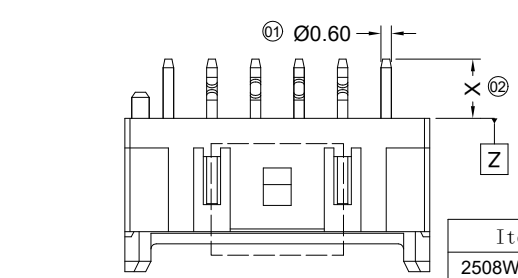

Item number	X value
2508WV-XX-XXXX	3.4mm
2508WV-XXP-XXXX	3.4mm
2508WV-XXP1-XXXX	3.4mm
2508WV-XXP2-XXXX	4.5mm
2508WV-XXN1-XXXX	3.4mm
2508WV-XXN2-XXXX	2.4mm
2508WV-XXN3-XXXX	4.5mm

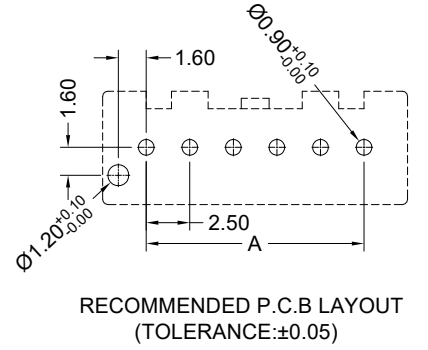
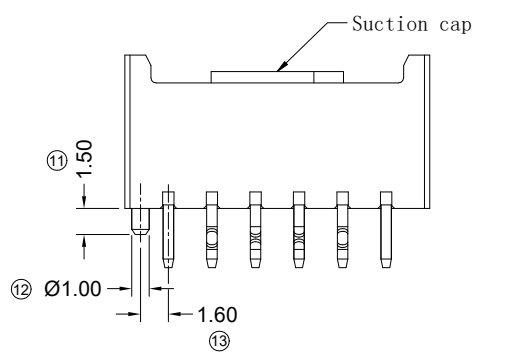
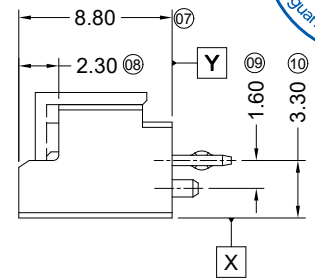
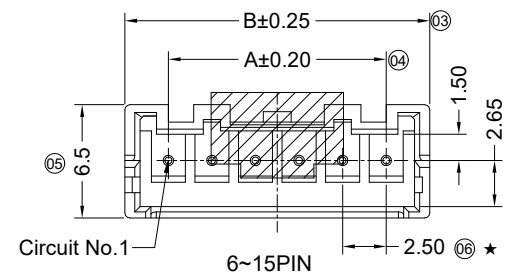
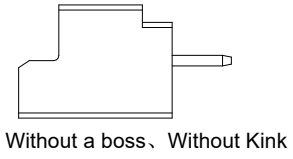
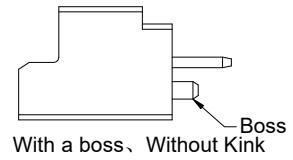
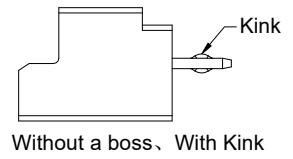
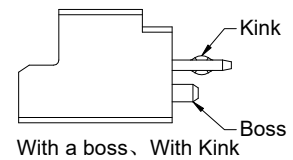
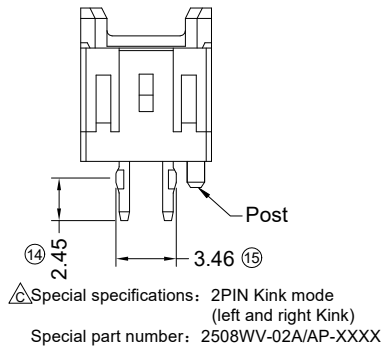
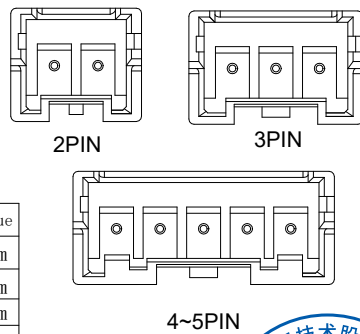

DATE	REV	ECN NO	DESCRIPTION	MODIFY	APPROVAL
2023/09/19	E1	/	Add encoding and description for P2, N2, and N3	Larry Lin	Jack Zhang
2021/08/18	E	EN20210818002	Add with cap p/n	Mali	Alan qin

GENERAL TOLERANCE				APPROVAL	CHECK	DRAWN	DATE	PART NO.				
.X	.XX	.XXX	X°					2508WV-XXXX-9TXXXXX				
±0.30	±0.20	±0.10	±2°	Alan qin	Alan qin	Alan qin	2017/11/21	TITLE				
2.50 mm Crimp Style connectors												
UNIT	SCALE	SHEET	REV	NUMBER								
mm	1:1	1/2	E1	A-000								

SMS 东莞市思索技术股份有限公司
 Dongguan SESO Technology Co.,Ltd.

RoHS

This products can apply to the SESO Doc NO. QA-3-04-005 of Environmental&Material Management Rules

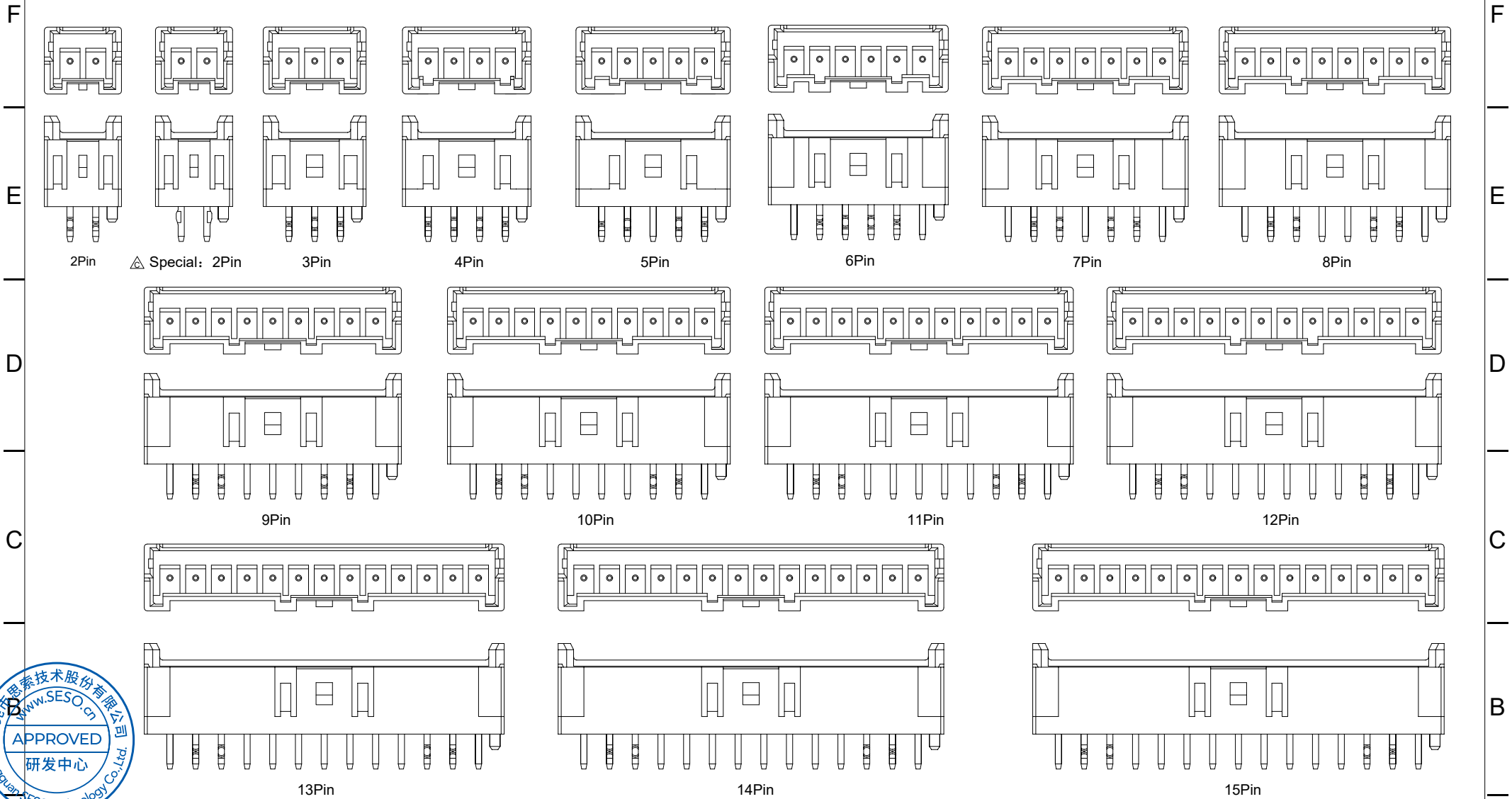

A	2023/09/19	E1	/	Add encoding and description for P2, N2, and N3	Larry Lin	Jack Zhang	 东莞市思索技术股份有限公司 Dongguan SESO Technology Co.,Ltd.	PART NO. 2508WV-XXXX-9TXXXXX								
	2021/08/18	E	EN20210818002	Add with cap p/n	Mali	Alan qin		TITLE 2.50 mm Crimp Style connectors								
	DATE	REV	ECN NO	DESCRIPTION	MODIFY	APPROVAL		PROJECT	APPROVAL	CHECK	DRAWN	DATE	UNIT	SCALE	SHEET	REV
										Alan qin	2017/11/21	mm	1:1	2/2	E1	A-000

RoHS

This products can apply to the SESO Doc NO. QA-3-04-005 of Environmental&Material Management Rules



Poles	Dimensions (mm)		Poles	Dimensions (mm)	
	A	B		A	B
02	2.50	7.50	09	20.00	25.00
03	5.00	10.00	10	22.50	27.50
04	7.50	12.50	11	25.00	30.00
05	10.00	15.00	12	27.50	32.50
06	12.50	17.50	13	30.00	35.00
07	15.00	20.00	14	32.50	37.50
08	17.50	22.50	15	35.00	40.00

Specifications :

- Voltage rating: 250V AC / DC
- Current rating: 3A AC / DC
- Withstanding voltage: 1000V AC/minute
- Temperature range: -40°C~+125°C
- Insulation resistance: ≥1000MΩ
- Contact resistance: ≤10mΩ
- After environmental testing: ≤20mΩ
- Material(Pin): Brass
- Mates With SESO Housing: 2508H、2513H

2508 W R X-XX X-9T SN X X - X
①① ①② ①③ ①④ ①⑤ ①⑥ ①⑦ ①⑧ ①⑨ ①⑩ ①⑪

- ① Series No.
- ② Category: W-Wafer
- ③ Connector Type: R-Right angle 90°
- ④ Mounting Type: Blank-DIP
- ⑤ Row No.-Pin No.: XX-02P~15P
- ⑥ Special No.: N-Without post and without kink
 △ Blank-Without post and with kink
- ⑦ Material: 9T-PA9T UL94V-0
- ⑧ Plating Code: SN-Bright Tin Plating
 Underplate: Ni 40~120u"(1~3um) overall
 Top plating: Sn 80~200u"(2~5um) overall
- ⑨ Color : Blank-Natural color; GW-Grey
- ⑩ Packing : Blank-PE bag、T-Tray

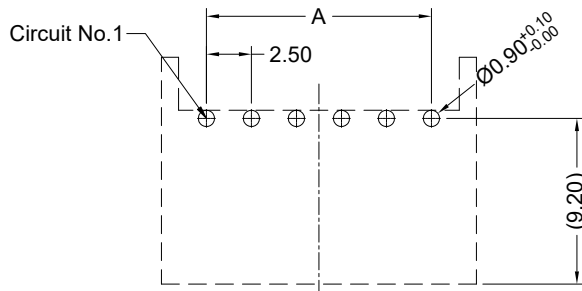
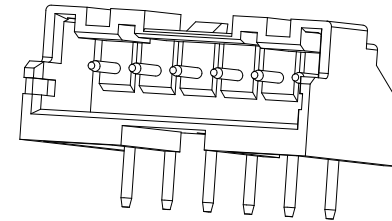
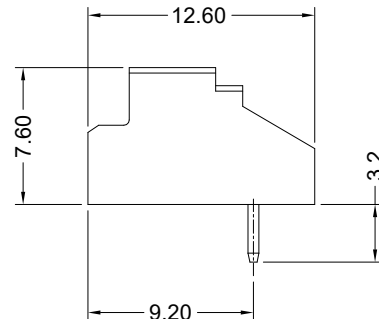
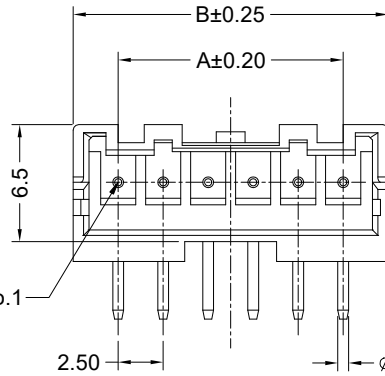
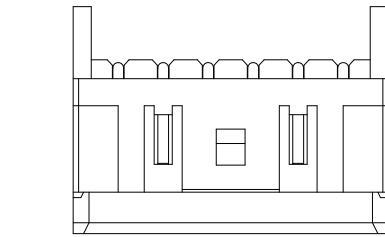

RECOMMENDED P.C.B LAYOUT T=1.60mm (TOLERANCE:±0.05)

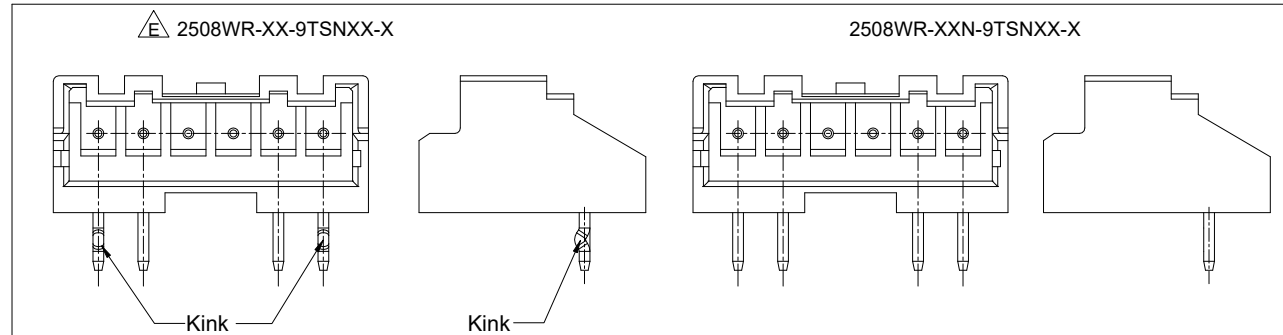

2023/10/31	F1	/	Update borders	Larry Lin	Jack Zhang
2021/05/06	F	EN120210506001	Add new product type	TengMin	John Yang
2021/03/31	E	EN120210331001	Add the specification with kink	Xin Qing	John Yang
DATE	REV	ECN NO.	DESCRIPTION	MODIFY	APPROVAL

GENERAL TOLERANCE	
.X	±0.30
.XX	±0.20
.XXX	±0.10
X.°	±2°
PROJECT	

SMS 东莞市思索技术股份有限公司
 Dongguan SESO Technology Co.,Ltd.

APPROVAL	CHECK	DRAWN	DATE
Jack Zhang	Larry Yang	Larry Lin	2018/04/16

PART NO.				
2508WR-XXX-9TSNXX-X				
TITLE				
2.50 mm Crimp Style connectors				
UNIT	SCALE	SHEET	REV	NUMBER
mm	1:1	1/2	F1	CD

RoHS

This products can apply to the SESO Doc NO. QA-3-04-005 of Environmental&Material Management Rules

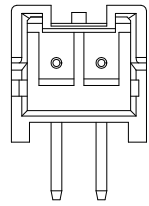

2Pin

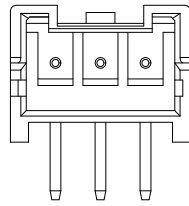

3Pin

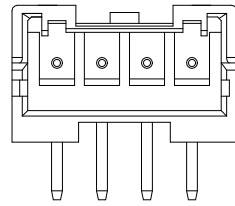

4Pin

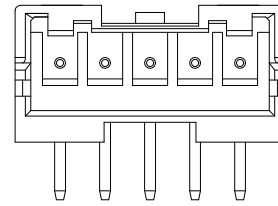

5Pin

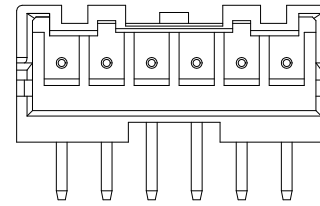

6Pin

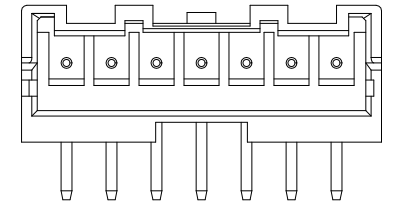

7Pin

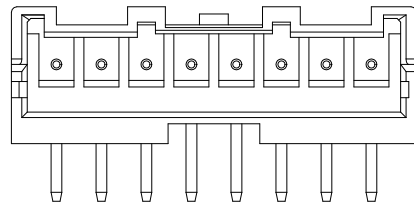

8Pin

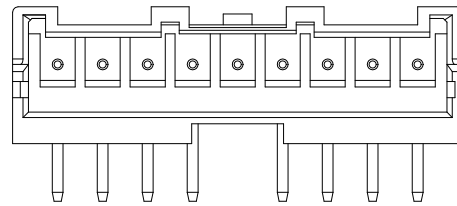

9Pin

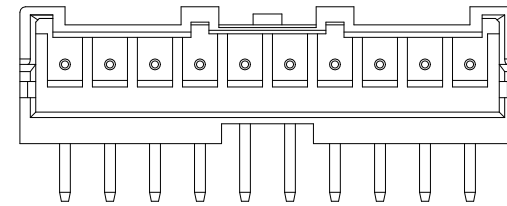

10Pin

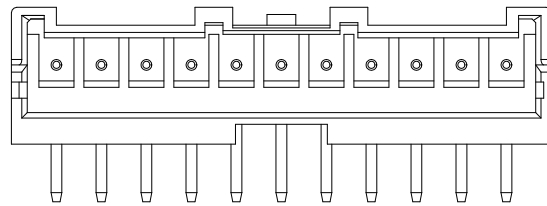

11Pin

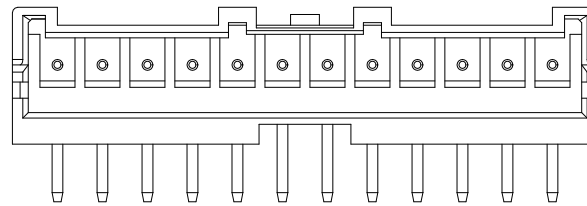

12Pin

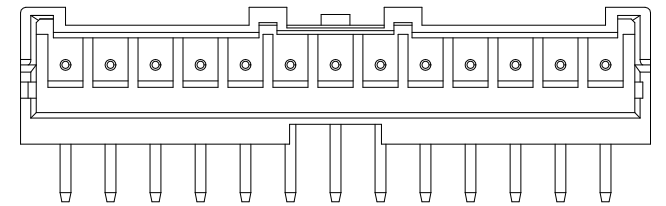

13Pin

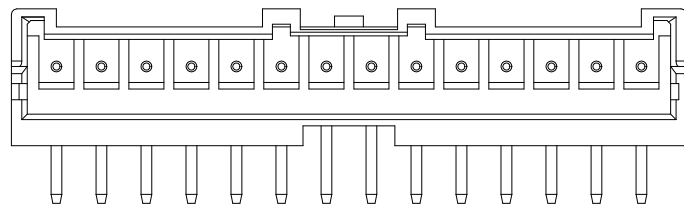

14Pin

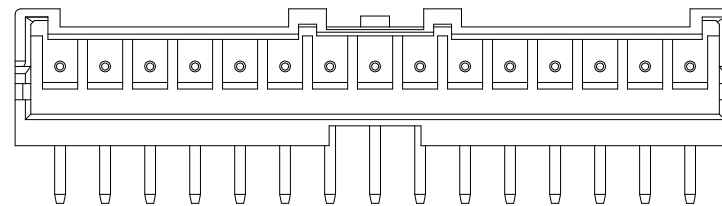

15Pin



2023/10/31	F1	/	Update borders	Larry Lin	Jack Zhang	GENERAL TOLERANCE .X ±0.30 .XX ±0.20 .XXX ±0.10 X.° ±2° PROJECT 	SMS 东莞市思索技术股份有限公司 Dongguan SESO Technology Co.,Ltd.				PART NO.							
2021/05/06	F	EN120210506001	Add new product type	TengMin	John Yang						2508WR-XXX-9TSNXX-X							
2021/03/31	E	EN120210331001	Add the specification with kink	Xin Qing	John Yang						APPROVAL	CHECK	DRAWN	DATE	TITLE			
DATE	REV	ECN NO.	DESCRIPTION	MODIFY	APPROVAL						Jack Zhang	Larry Yang	Larry Lin	2018/04/16	2.50 mm Crimp Style connectors			
											UNIT	SCALE	SHEET	REV	NUMBER			
											mm	1:1	2/2	F1	CD			

RoHS

This products can apply to the SESO Doc NO. QA-3-04-005 of Environmental&Material Management Rules



Poles	Dimensions (mm)		Poles	Dimensions (mm)	
	A	B		A	B
02	2.50	7.50	09	20.00	25.00
03	5.00	10.00	10	22.50	27.50
04	7.50	12.50	11	25.00	30.00
05	10.00	15.00	12	27.50	32.50
06	12.50	17.50	13	30.00	35.00
07	15.00	20.00	14	32.50	37.50
08	17.50	22.50	15	35.00	40.00

Specifications :

- Voltage rating: 250V AC / DC
- Current rating: 3A AC / DC
- Withstanding voltage: 1000V AC/minute
- Temperature range: -40°C~+125°C
- Insulation resistance: ≥1000MΩ
- Contact resistance: ≤10mΩ
- After environmental testing: ≤20mΩ
- Material(Pin): Brass
- Mates With SESO Housing: 2508H、2513H

2508 W R X-XX X- 9T SN X X
 ①② ③④⑤ ⑥⑦ ⑧⑨ ⑩

- ① Series No.
- ② Category: W-Wafer
- ③ Connector Type: R-Right angle 90°
- ④ Mouting Type: Blank-DIP
- ⑤ Row No.-Pin No.: XX-02P~15P
- ⑥ Special No.: S-With post and with kink
 △ S1-With post and without kink
- ⑦ Material: 9T-PA9T UL94V-0
- ⑧ Plating Code: SN-Bright Tin Plating
 Underplate: Ni 40~120u"(1~3um) overall
 Top plating: Sn 80~200u"(2~5um) overall
- ⑨ Color : Blank-Natural color; GW-Grey
- ⑩ Packing : Blank-PE bag、 T-Tray

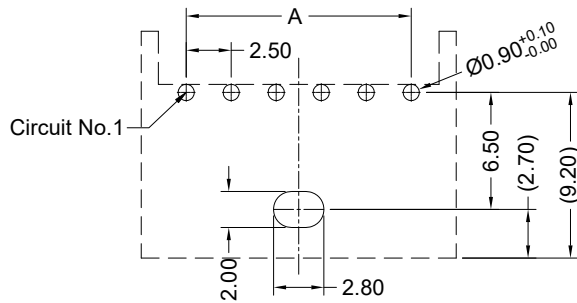
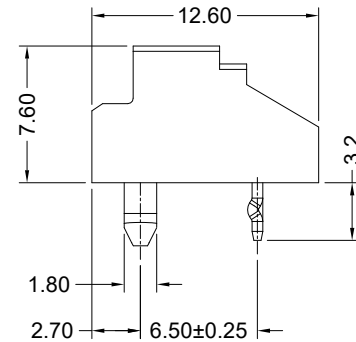
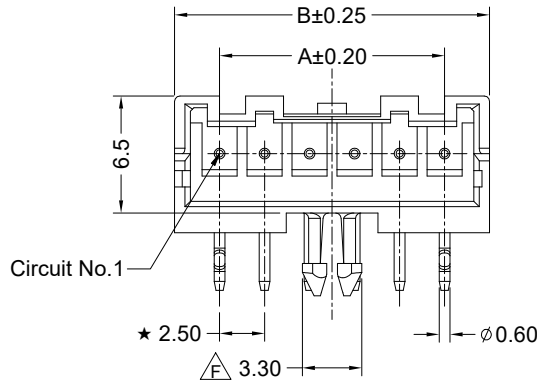
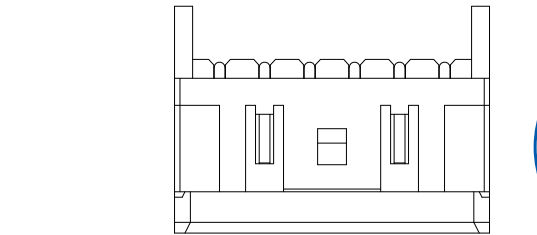

RECOMMENDED P.C.B LAYOUT T=1.60mm (TOLERANCE:±0.05)

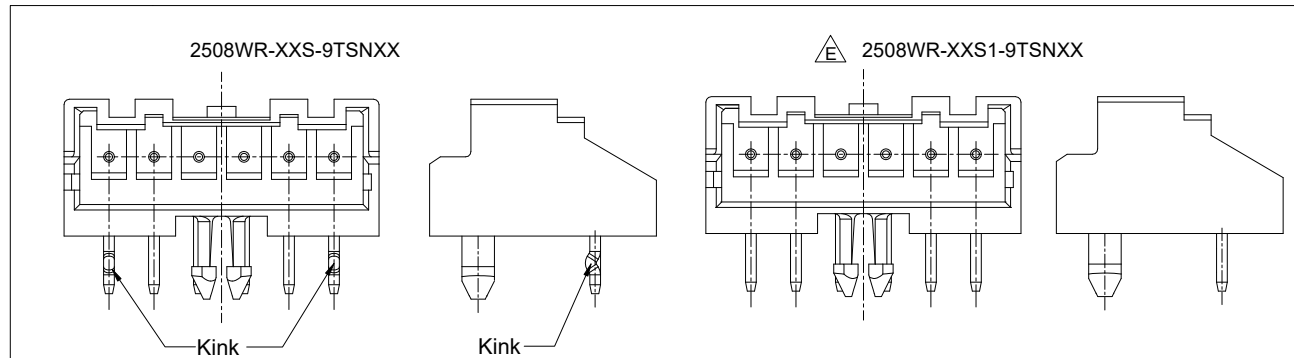

DATE	REV	ECN NO.	DESCRIPTION	MODIFY	APPROVAL
2023/10/31	F1	/	Update borders	Larry Lin	Jack Zhang
2021/05/06	F	EN120210506001	Modify the post structure	Cai Zhao	John Yang
2021/03/31	E	EN120210331001	Add the specification without kink	Xin Qing	John Yang

GENERAL TOLERANCE	
.X	±0.30
.XX	±0.20
.XXX	±0.10
X.°	±2°
PROJECT	
①	②

SMS 东莞市思索技术股份有限公司
 Dongguan SESO Technology Co.,Ltd.

APPROVAL	CHECK	DRAWN	DATE
Jack Zhang	Larry Yang	Larry Lin	2017/11/21

PART NO.				
2508WR-XXX-9TSNXX				
TITLE				
2.50 mm Crimp Style connectors				
UNIT	SCALE	SHEET	REV	NUMBER
mm	1:1	1/2	F1	CD

RoHS

This products can apply to the SESO Doc NO. QA-3-04-005 of Environmental&Material Management Rules

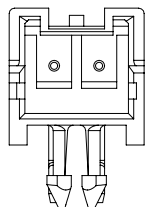

2Pin

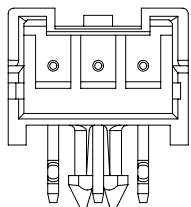

3Pin

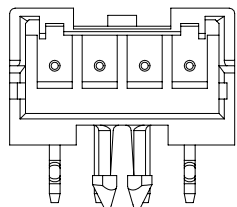

4Pin

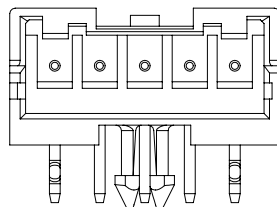

5Pin

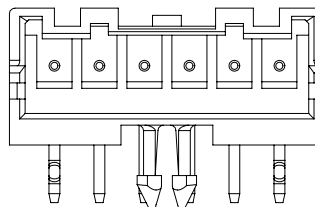

6Pin

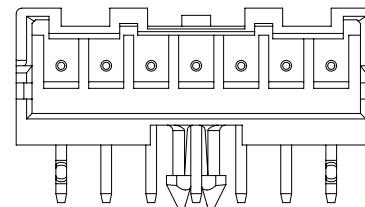

7Pin

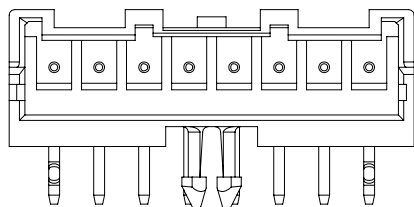

8Pin

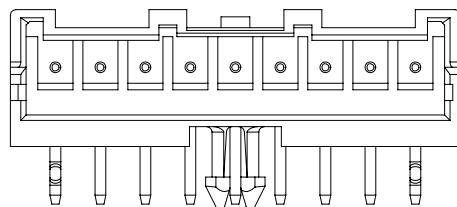

9Pin

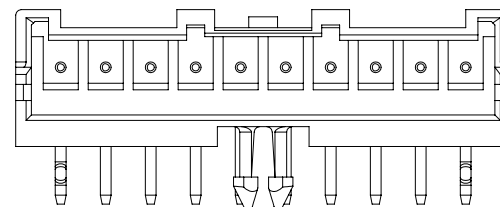

10Pin

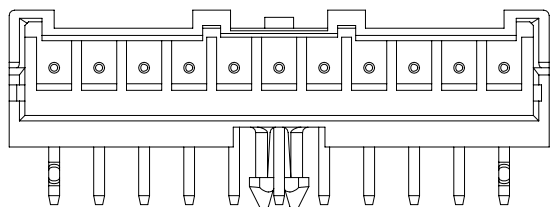

11Pin

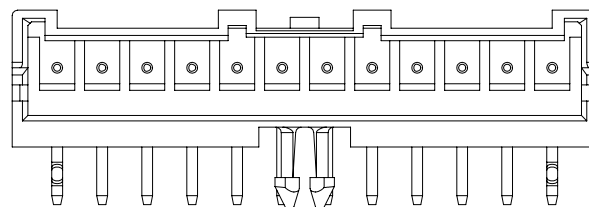

12Pin

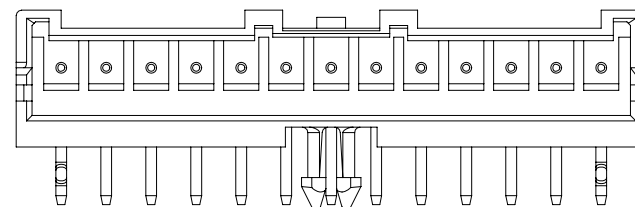

13Pin

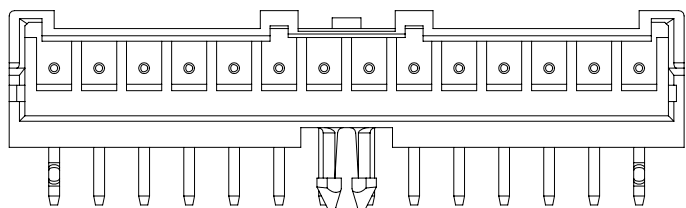

14Pin

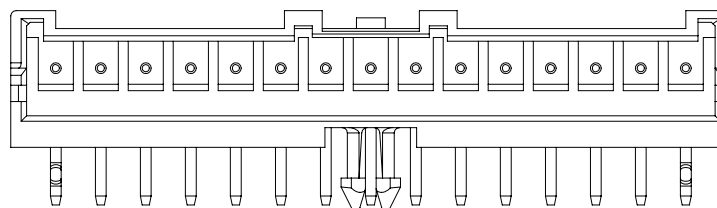

15Pin



2023/10/31	F1	/	Update borders	Larry Lin	Jack Zhang	GENERAL TOLERANCE .X ±0.30 .XX ±0.20 .XXX ±0.10 X.° ±2° PROJECT 	东莞市思索技术股份有限公司 Dongguan SESO Technology Co.,Ltd.				PART NO. 2508WR-XXX-9TSNXX				
2021/05/06	F	EN120210506001	Modify the post structure	Cai Zhao	John Yang						APPROVAL				TITLE 2.50 mm Crimp Style connectors
2021/03/31	E	EN120210331001	Add the specification without kink	Xin Qing	John Yang		CHECK				DATE				
DATE	REV	ECN NO.	DESCRIPTION	MODIFY	APPROVAL		DRAWN				UNIT mm				
						DATE				SCALE 1:1					
						DRAWN				SHEET 2/2					
						DATE				REV F1					
						DATE				NUMBER CD					

RoHS

This products can apply to the SESO Doc NO. QA-3-04-005 of Environmental&Material Management Rules



Poles	Dimensions (mm)		Poles	Dimensions (mm)	
	A	B		A	B
02	2.50	7.50	09	20.00	25.00
03	5.00	10.00	10	22.50	27.50
04	7.50	12.50	11	25.00	30.00
05	10.00	15.00	12	27.50	32.50
06	12.50	17.50	13	30.00	35.00
07	15.00	20.00	14	32.50	37.50
08	17.50	22.50	15	35.00	40.00

Specifications :

- Voltage rating: 250V AC / DC
- Current rating: 3A AC / DC
- Withstanding voltage: 1000V AC/minute
- Temperature range: -40°C~+125°C
- Insulation resistance: ≥1000MΩ
- Contact resistance: ≤10mΩ
- After environmental testing: ≤20mΩ
- Material(Pin): Brass
- Mates With SESO Housing: 2508H、2513H

2508 W R X-XX X-N0 SN X X - X
①① ①② ①③ ①④ ①⑤ ①⑥ ①⑦ ①⑧ ①⑨ ①⑩ ①⑪

- ① Series No.
- ② Category: W-Wafer
- ③ Connector Type: R-Right angle 90°
- ④ Mouting Type: Blank-DIP
- ⑤ Row No.-Pin No.: XX-02P~15P
- ⑥ Special No.: N-Without post and without kink
 △ Blank-Without post and with kink
- ⑦ Material: N0-PA66 UL94V-0
- ⑧ Plating Code: SN-Bright Tin Plating
 Underplate: Ni 40~120u"(1~3um) overall
 Top plating: Sn 80~200u"(2~5um) overall
- ⑨ Color : Blank-Natural color; GW-Grey; R-Red △
- ⑩ Packing : Blank-PE bag、T-Tray
- ⑪ C- The glow-wire test of 750°C △

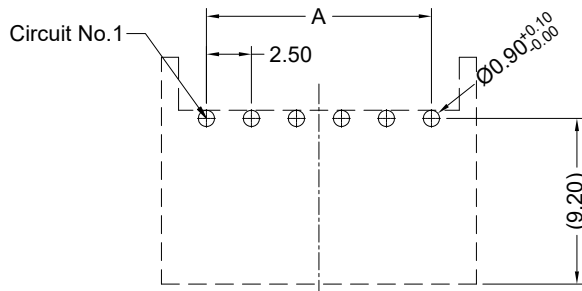
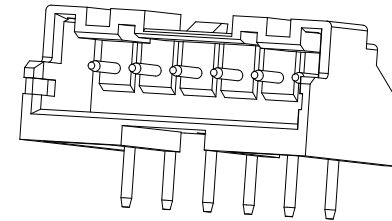
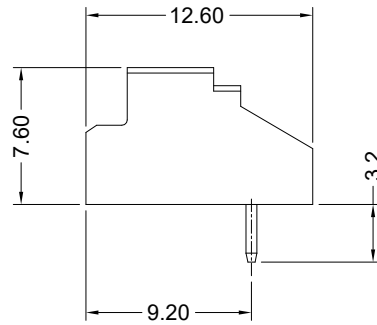
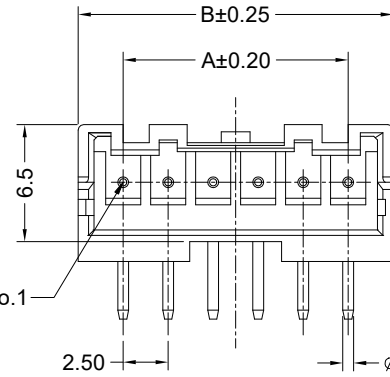
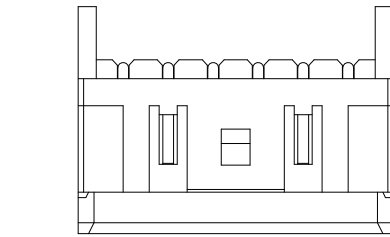

RECOMMENDED P.C.B LAYOUT T=1.60mm (TOLERANCE:±0.05)

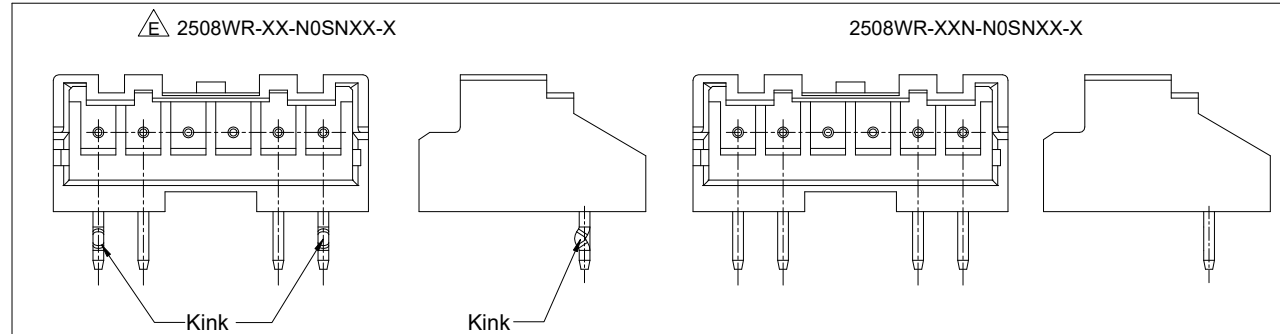

2023/10/31	F1	/	Update borders	Larry Lin	Jack Zhang
2021/05/06	F	EN120210506001	Add new product type	TengMin	John Yang
2021/03/31	E	EN120210331001	Add the specification with kink and red	Xin Qing	John Yang
DATE	REV	ECN NO.	DESCRIPTION	MODIFY	APPROVAL

GENERAL TOLERANCE	
.X	±0.30
.XX	±0.20
.XXX	±0.10
X.°	±2°
PROJECT	

SMS 东莞市思索技术股份有限公司
 Dongguan SESO Technology Co.,Ltd.

APPROVAL	CHECK	DRAWN	DATE
Jack Zhang	Larry Yang	Larry Lin	2018/04/16

PART NO.				
2508WR-XXX-N0SNXX-X				
TITLE				
2.50 mm Crimp Style connectors				
UNIT	SCALE	SHEET	REV	NUMBER
mm	1:1	1/2	F1	CD

RoHS

This products can apply to the SESO Doc NO. QA-3-04-005 of Environmental&Material Management Rules

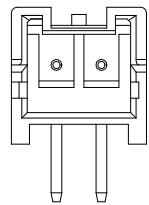

2Pin

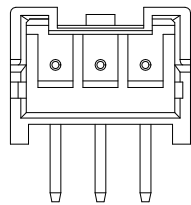

3Pin

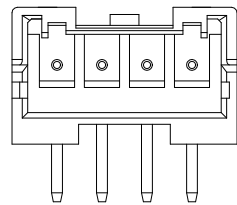

4Pin

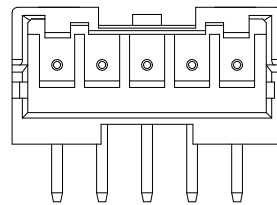

5Pin

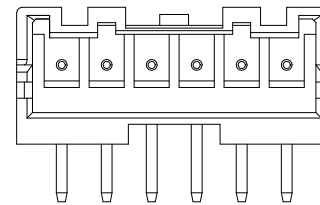

6Pin

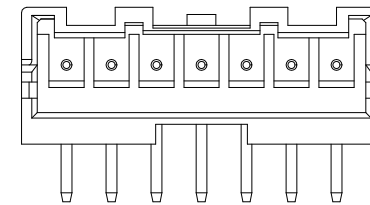

7Pin

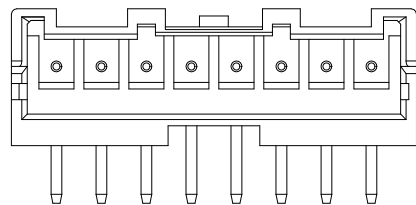

8Pin

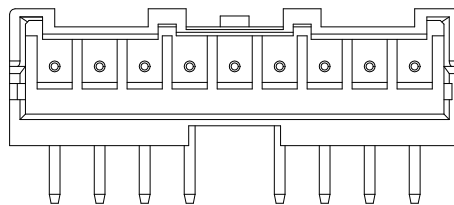

9Pin

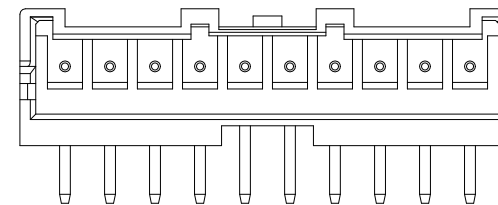

10Pin

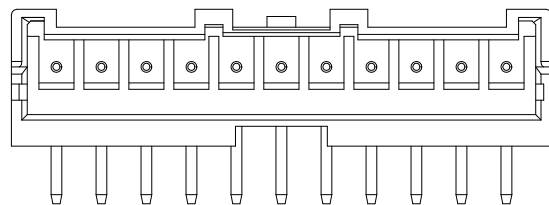

11Pin

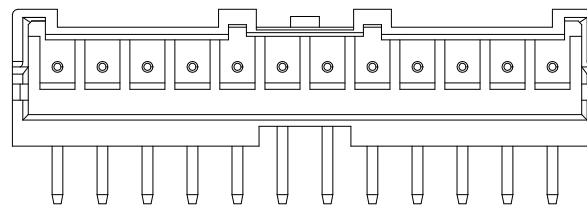

12Pin

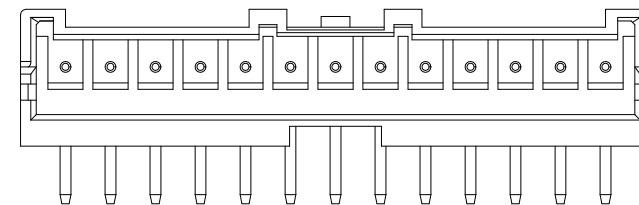

13Pin

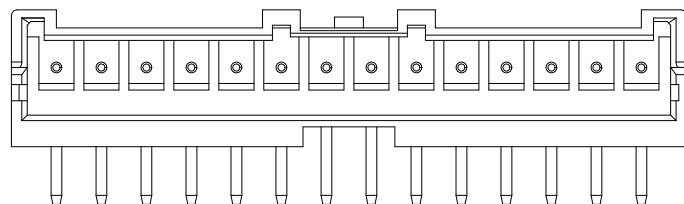

14Pin

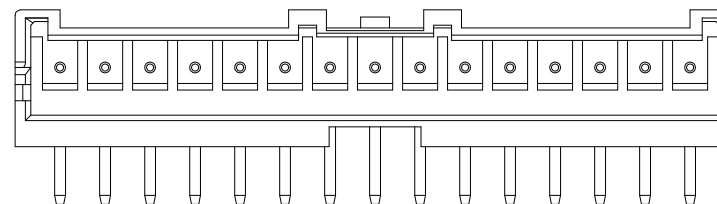

15Pin



2023/10/31	F1	/	Update borders	Larry Lin	Jack Zhang	GENERAL TOLERANCE .X ±0.30 .XX ±0.20 .XXX ±0.10 X.° ±2° PROJECT 	SMS 东莞市思索技术股份有限公司 Dongguan SESO Technology Co.,Ltd.				PART NO. 2508WR-XXX-N0SNXX-X							
2021/05/06	F	EN120210506001	Add new product type	TengMin	John Yang						TITLE 2.50 mm Crimp Style connectors							
2021/03/31	E	EN120210331001	Add the specification with kink and red	Xin Qing	John Yang						APPROVAL	CHECK	DRAWN	DATE	UNIT SCALE SHEET REV NUMBER			
DATE	REV	ECN NO.	DESCRIPTION	MODIFY	APPROVAL						Jack Zhang	Larry Yang	Larry Lin	2018/04/16	mm	1:1	2/2	F1

1 | 2 | 3 | 4 | 5 | 6 | 7 | 8

RoHS

This products can apply to the SESO Doc NO. QA-3-04-005 of Environmental&Material Management Rules

■ Specifications :

- Voltage rating: 250V AC / DC
- Current rating: 3A AC / DC
- Withstanding voltage:1000V AC/minute
- Temperature range: -40°C~+125°C
- Insulation resistance:≥1000MΩ
- Contact resistance: ≤10mΩ
- After environmental testing: ≤20mΩ
- Material(Pin):Brass
- Mates With SESO Housing:2508H、2513H

Poles	Dimensions (mm)		Poles	Dimensions (mm)	
	A	B		A	B
02	2.50	7.50	09	20.00	25.00
03	5.00	10.00	10	22.50	27.50
04	7.50	12.50	11	25.00	30.00
05	10.00	15.00	12	27.50	32.50
06	12.50	17.50	13	30.00	35.00
07	15.00	20.00	14	32.50	37.50
08	17.50	22.50	15	35.00	40.00



2508 W R X-XX X- N0 SN X X - X
 ①① ①② ①③ ①④ ①⑤ ①⑥ ①⑦ ①⑧ ①⑨ ①⑩ ①⑪

- ① Series No.
- ② Category: W-Wafer
- ③ Connector Type: R-Right angle 90°
- ④ Mouting Type: Blank-DIP
- ⑤ Row No.-Pin No.: XX-02P~15P
- ⑥ Special No.:S-With post and with kink
 △ S1-With post and without kink
- ⑦ Material: N0-PA66 UL94V-0
- ⑧ Plating Code: SN-Bright Tin Plating
 Underplate:Ni 40~120u"(1~3um) overall
 Top plating:Sn 80~200u"(2~5um) overall
- ⑨ Color : Blank-Natural color; GW-Grey;R-Red △
- ⑩ Packing : Blank-PE bag、T-Tray
- ⑪ C- The glow-wire test of 750°C △

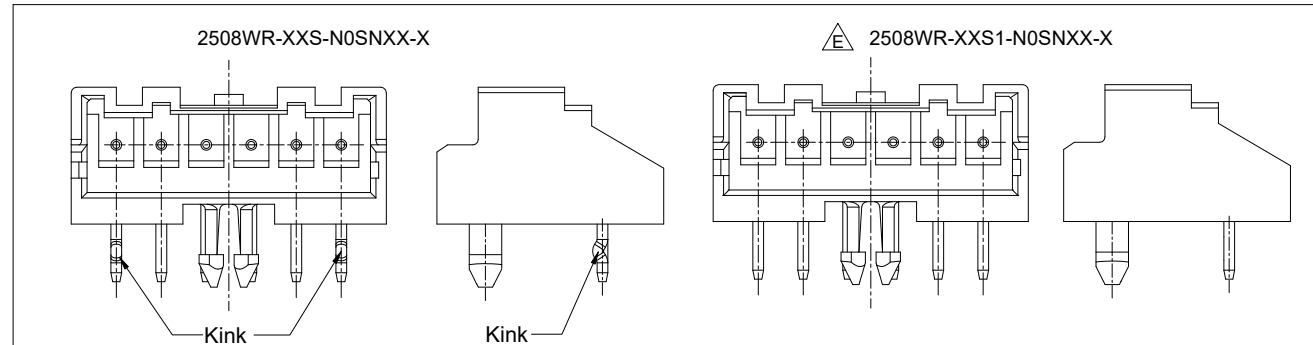
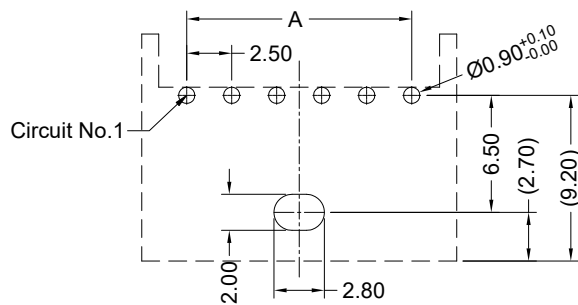
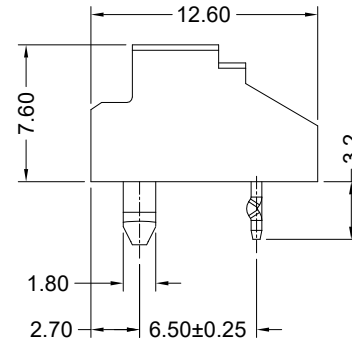
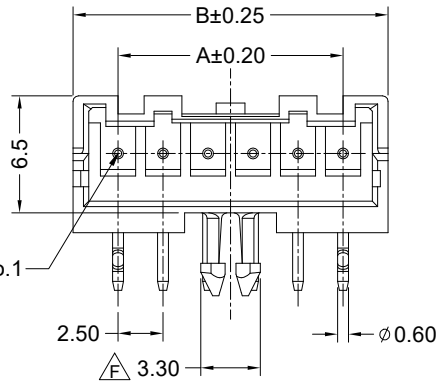
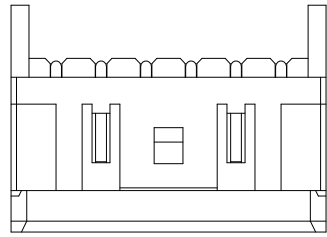

DATE	REV	ECN NO.	DESCRIPTION	MODIFY	APPROVAL	PROJECT	APPROVAL	CHECK	DRAWN	DATE	UNIT	SCALE	SHEET	REV	NUMBER
2023/10/31	F1	/	Update borders	Larry Lin	Jack Zhang	GENERAL TOLERANCE	APPROVAL	CHECK	DRAWN	DATE	mm	1:1	1/2	F1	CD
2021/05/06	F	EN120210506001	Modify the post structure and add new product type	Cai Zhao	John Yang	.X ±0.30	Jack Zhang	Larry Yang	Larry Lin	2017/11/21					
2021/03/31	E	EN120210331001	Add the specification without kink and red	Xin Qing	John Yang	.XX ±0.20									
						.XXX ±0.10									
						X.° ±2°									
PART NO. 2508WR-XXX-N0SNXX-X											TITLE 2.50 mm Crimp Style connectors				
PROJECT											UNIT				
APPROVAL											SCALE				
CHECK											SHEET				
DRAWN											REV				
DATE											NUMBER				

SMS 东莞市思索技术股份有限公司
 Dongguan SESO Technology Co.,Ltd.

PART NO. 2508WR-XXX-N0SNXX-X
 TITLE 2.50 mm Crimp Style connectors
 UNIT mm SCALE 1:1 SHEET 1/2 REV F1 NUMBER CD

RoHS

This products can apply to the SESO Doc NO. QA-3-04-005 of Environmental&Material Management Rules

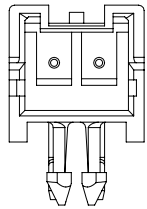

2Pin

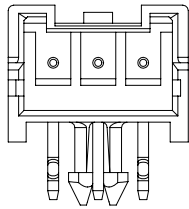

3Pin

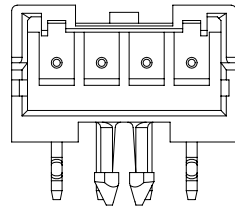

4Pin

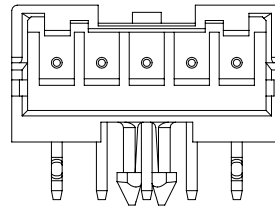

5Pin

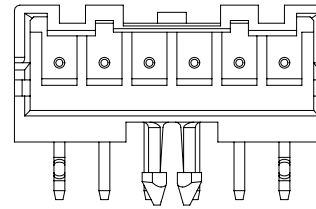

6Pin

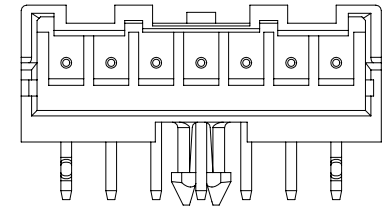

7Pin

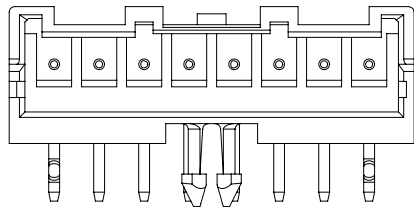

8Pin

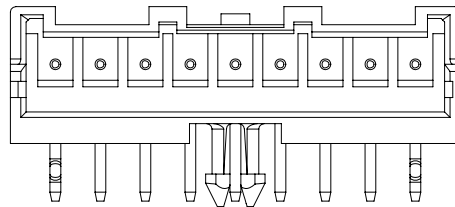

9Pin

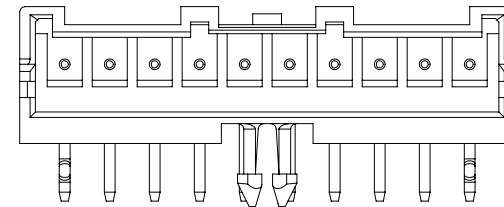

10Pin

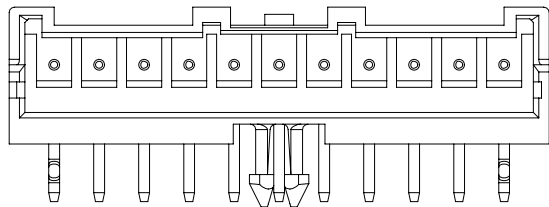

11Pin

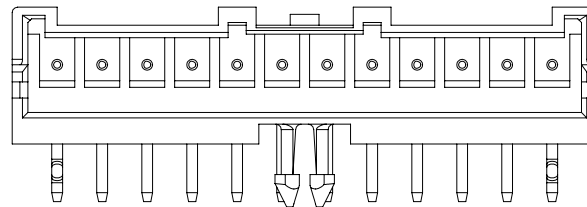

12Pin

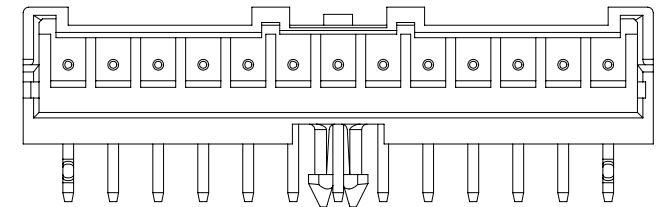

13Pin

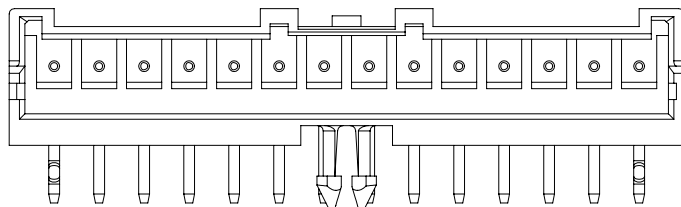

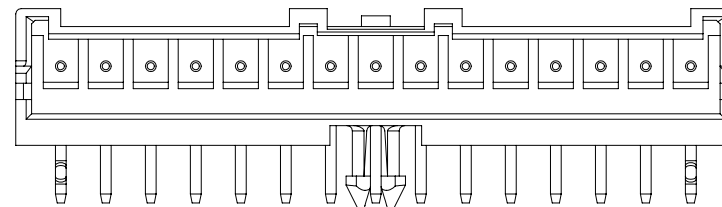

14Pin



15Pin



2023/10/31	F1	/	Update borders	Larry Lin	Jack Zhang	 东莞市思索技术股份有限公司 Dongguan SESO Technology Co.,Ltd.				PART NO. 2508WR-XXX-N0SNXX-X								
2021/05/06	F	EN120210506001	Modify the post structure and add new product type	Cai Zhao	John Yang					GENERAL TOLERANCE				TITLE 2.50 mm Crimp Style connectors				
2021/03/31	E	EN120210331001	Add the specification without kink and red	Xin Qing	John Yang					.X ±0.30				APPROVAL				
										.XX ±0.20				CHECK				
										.XXX ±0.10				DRAWN				
DATE	REV	ECN NO.	DESCRIPTION	MODIFY	APPROVAL	X.° ±2°				DATE								
						PROJECT				2017/11/21								
										Jack Zhang Larry Yang Larry Lin								

RoHS

This products can apply to the SESO Doc NO. QA-3-04-005 of Environmental&Material Management Rules



Poles	Dimensions/mm			
	A	B	C	D
2	2.50	5.75	10.00	4.05
3	5.00	8.25	12.50	5.75
4	7.50	10.75	15.00	9.20
5	10.00	13.25	17.50	11.35
6	12.50	15.75	20.00	13.85
7	15.00	18.25	22.50	16.35
8	17.50	20.75	25.00	18.85
9	20.00	23.25	27.50	21.35
10	22.50	25.75	30.00	23.85
11	25.00	28.25	32.50	26.35
12	27.50	30.75	35.00	28.85
13	30.00	33.25	37.50	31.35
14	32.50	35.75	40.00	33.85
15	35.00	38.25	42.50	36.35

Specifications:

- Voltage Rating:250V AC/DC
- Current Rating:3A AC/DC
- Withstanding Voltage:1000V AC/Minute
- Temperature Range:-40°C~+125°C
- Insulation Resistance:100MΩ Min./500V DC/Minute
- Contact Resistance:<10mΩ (Initial)
<20mΩ (After Testing)
- Mates With Housing:2508H-XX, 2513H-XX
- Product Specification:PS-2513-02
- Packaging Drawing:PK-2508WVS-XXE-9TXNX
- Symbols for SPC Dimensions:"★"

2508 W V S-XX E-9T X N X
① ② ③ ④ ⑤ ⑥ ⑦ ⑧ ⑨ ⑩

- ① Series No.:2508
- ② Category:W-Wafer
- ③ Connector Type:V-Straight 180°
- ④ Mounting Type:S-SMT
- ⑤ Row No.-Pin No.:
XX-Single Row-02Pin~15Pin
- ⑥ Special No.:E-Stamping Terminal
- ⑦ Plastic Material:9T-PA9T (UL94V-0)
- ⑧ Planting Code:SW1-Matte Tin
Underplate:Ni 40~120u"(1~3um) overall
Top Plating:Sn 80~200u"(2~5um) overall
- △ GW01-Underplate:Ni 40~120u"(1~3um) overall
Contact area Plating Au 1U"(0.025um)Min
Weld area Plating Sn 80~200u"(2~5um)
- ⑨ Color:N-Natural
- ⑩ Packing:X-R:Reel ; C:With Cap

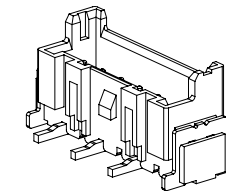
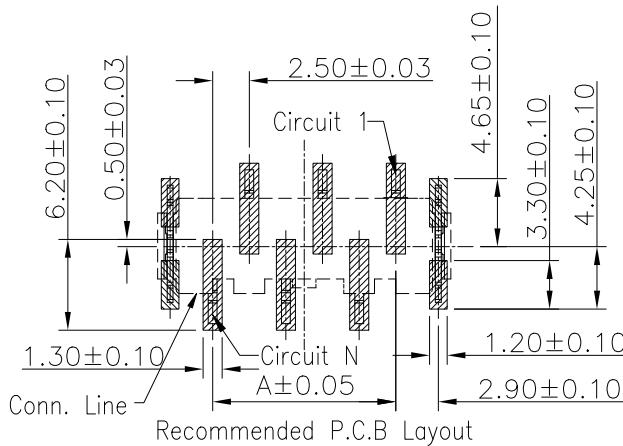
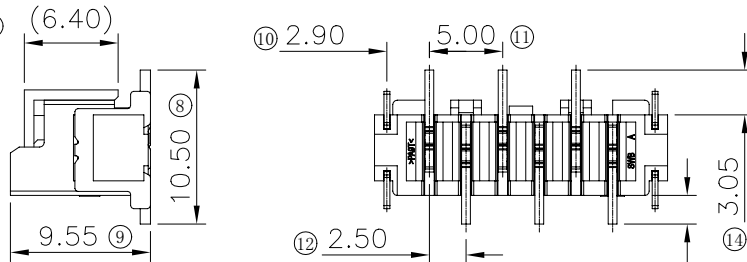
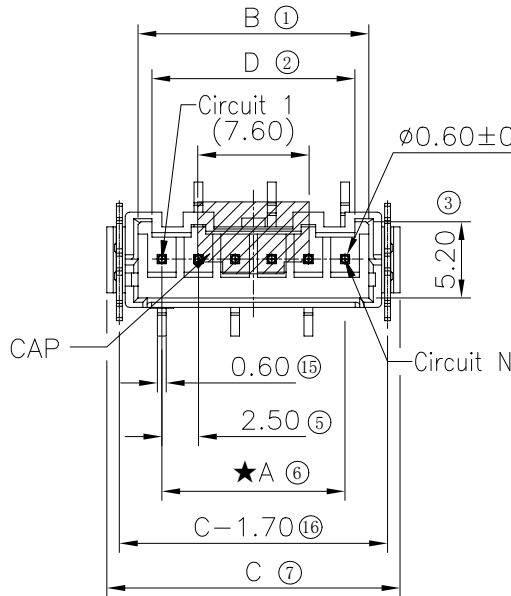
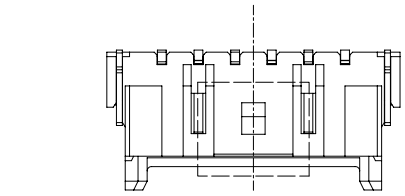

Without Cap

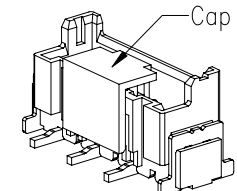

With Cap

20230706	B4	/	Modify the 3Pin size D according to the shell diagram	Zhou	Larry
20230630	B3	/	Increase the size ⑮ ⑯	Zhou	Larry
20230615	B2	/	ADD the CAP view	Zhou	Larry
DATE	REV	ECN NO.	DESCRIPTION	MODIFY	APPROVAL

GENERAL TOLERANCE	
.X	±0.35
.XX	±0.25
.XXX	±0.15
X.°	±2°
PROJECT	

SMS 东莞市思索技术股份有限公司
Dongguan SESO Technology Co.,Ltd.

APPROVAL	CHECK	DRAWN	DATE
Kevin	John Yang	Cai Zhao	2021/03/12

PART NO.				
2508WVS-XXE-9TXNX				
TITLE: 2.50mm WF				
ASSY vertical SMT				
UNIT	SCALE	SHEET	REV	NUMBER
mm	1:1	1/2	B4	A-000

RoHS

This products can apply to the SESO Doc NO. QA-3-04-005 of Environmental&Material Management Rules



02 Pin

03 Pin

04 Pin

05 Pin

06~15 Pin

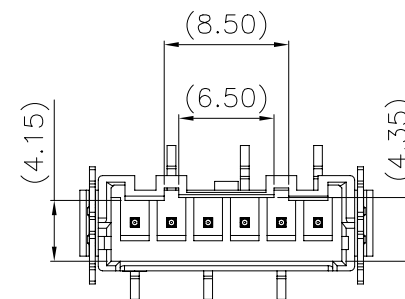
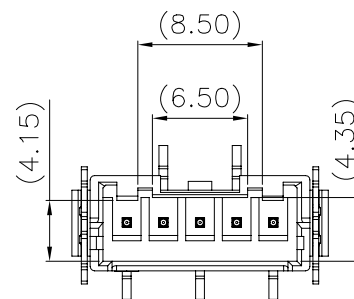
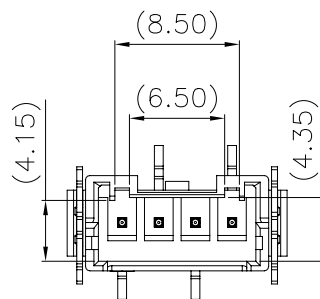
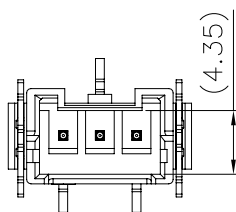
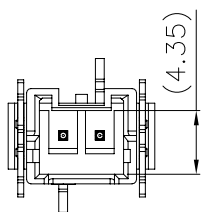
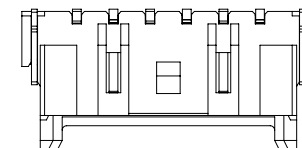
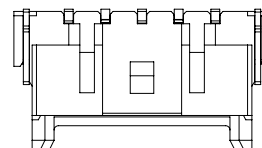
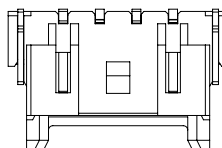
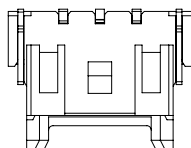
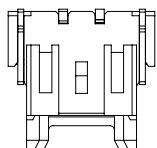

20230706	B4	/	Modify the 3Pin size D according to the shell diagram	Zhou	Larry	东莞市思索技术有限公司 Dongguan SESO Technology Co.,Ltd.				PART NO. 2508WVS-XXE-9TXNX								
20230630	B3	/	Increase the size (15)(16)	Zhou	Larry					GENERAL TOLERANCE				TITLE: 2.50mm WF ASSY vertical SMT				
20230615	B2	/	ADD the CAP view	Zhou	Larry					.X ±0.35				APPROVAL CHECK DRAWN DATE				
DATE	REV	ECN NO.	DESCRIPTION	MODIFY	APPROVAL					.XX ±0.25				UNIT SCALE SHEET REV NUMBER				
						.XXX ±0.15				mm 1:1 2/2 B4 A-000								
						X° ±2°				Kevin John Yang Cai Zhao 2021/03/12								
						PROJECT												

RoHS

This products can apply to the SESO Doc NO. QA-3-04-005 of Environmental&Material Management Rules



Poles	Dimensions/mm			
	A	B	C	D
2	2.50	5.75	10.00	4.05
3	5.00	8.25	12.50	5.75 [△]
4	7.50	10.75	15.00	9.20
5	10.00	13.25	17.50	11.35
6	12.50	15.75	20.00	13.85
7	15.00	18.25	22.50	16.35
8	17.50	20.75	25.00	18.85
9	20.00	23.25	27.50	21.35
10	22.50	25.75	30.00	23.85
11	25.00	28.25	32.50	26.35
12	27.50	30.75	35.00	28.85
13	30.00	33.25	37.50	31.35
14	32.50	35.75	40.00	33.85
15	35.00	38.25	42.50	36.35

Specifications:

- Voltage Rating:250V AC/DC
- Current Rating:3A AC/DC
- Withstanding Voltage:1000V AC/Minute
- Temperature Range:-40°C~+125°C
- Insulation Resistance:100MΩ Min./500V DC/Minute
- Contact Resistance:<10mΩ (Initial)
<20mΩ (After Testing)
- Mates With Housing:2508H-XX, 2513H-XX
- Product Specification:PS-2513-02
- Packaging Drawing:PK-2508WRS-XXE-9TXNR
- Symbols for SPC Dimensions:"★"

2508 W R S-XX E-9T X N R
① ②③④ ⑤ ⑥ ⑦ ⑧ ⑨⑩

- ① Series No.:2508
- ② Category:W-Wafer
- ③ Connector Type:R-Right Angle 90°
- ④ Mouting Type:S-SMT
- ⑤ Row No.-Pin No.:
XX-Single Row-02Pin~15Pin
- ⑥ Special No.:E-Stamping Terminal
- ⑦ Plastic Material:9T-PA9T (UL94V-0)
- ⑧ Plating Code:SW1-Matte Tin
Underplate:Ni 40~120u"(1~3um) overall
Top Plating:Sn 80~200u"(2~5um) overall
GW01-Underplate:Ni 40~120u"(1~3um) overall
Contact area Plating Au 1U"(0.025um)Min
Weld area Plating Sn 80~200u"(2~5um)
- ⑨ Color:N-Natural
- ⑩ Packing:R-Reel

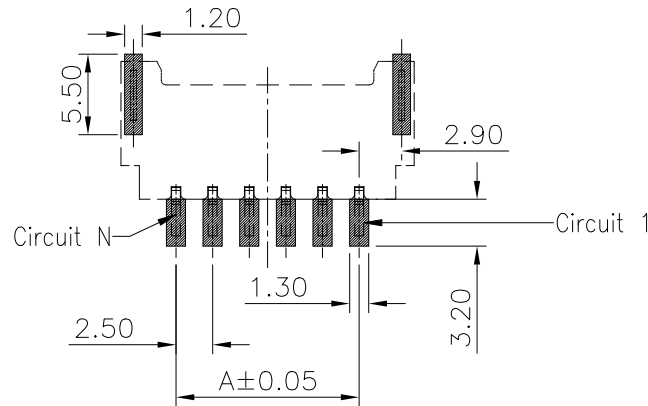
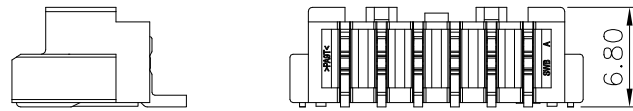
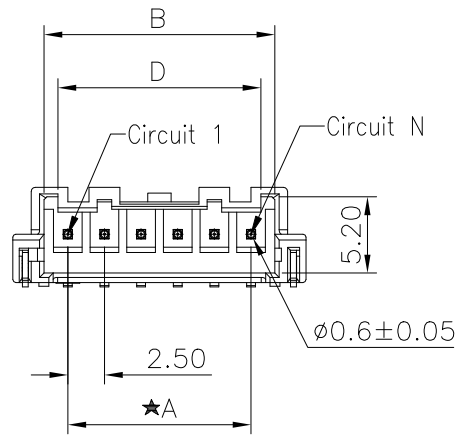
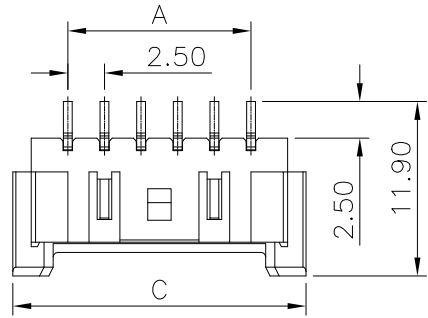
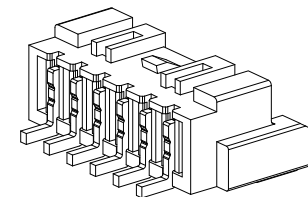

Recommended P.C.B Layout(T=1.6mm)
(TOLERANCE:±0.05)

20240429	B2	EN20240510002	The D dimension annotation of 3-pin is incorrect and needs to be updated	Kale Lin	Jack Zhang	GENERAL TOLERANCE .X ±0.35 .XX ±0.25 .XXX ±0.15 X.' ±2'	APPROVAL	CHECK	DRAWN	DATE	PART NO. 2508WRS-XXE-9TXNR
20231031	B1	/	Update borders	Larry Lin	Jack Zhang						
20210415	B	EN120210415001	Add the Planting Code GW01	Cai Zhao	John Yang	PROJECT APPROVAL	Jack Zhang	Larry Yang	Kale Lin	2021/03/12	UNIT mm
DATE	REV	ECN NO.	DESCRIPTION	MODIFY	APPROVAL	PROJECT	Jack Zhang	Larry Yang	Kale Lin	2021/03/12	SCALE 1:1
						PROJECT					SHEET 1/2
						PROJECT					REV B2
						PROJECT					NUMBER CD

SMS 东莞市思索技术股份有限公司
Dongguan SESO Technology Co.,Ltd.

RoHS

This products can apply to the SESO Doc NO. QA-3-04-005 of Environmental&Material Management Rules



02 Pin

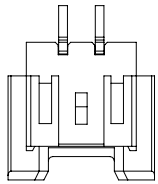

03 Pin

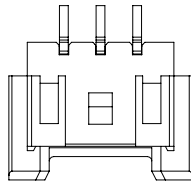

04 Pin

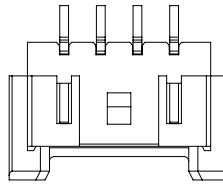

05 Pin

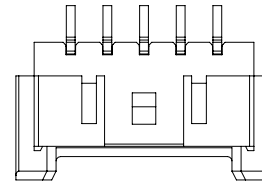

06~15 Pin

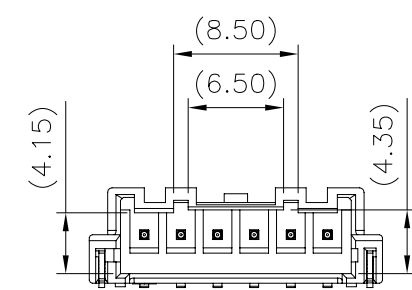
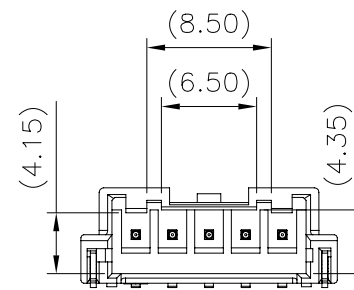
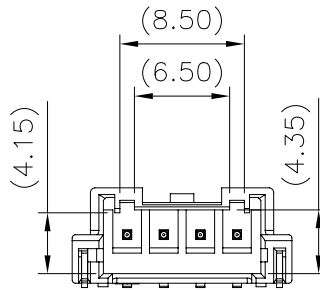
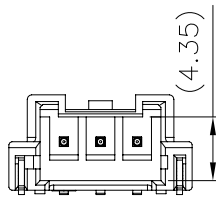
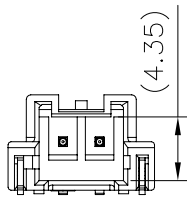
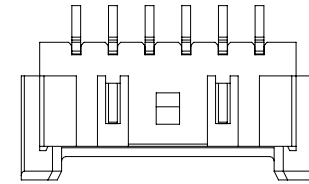

20240429	B2	EN20240510002	The D dimension annotation of 3-pin is incorrect and needs to be updated	Kale Lin	Jack Zhang	东莞市思索技术股份有限公司 Dongguan SESO Technology Co.,Ltd.				PART NO. 2508WRS-XXE-9TXNR																																
20231031	B1	/	Update borders	Larry Lin	Jack Zhang					<table border="1"> <tr> <td colspan="4">GENERAL TOLERANCE</td> </tr> <tr> <td>.X</td> <td>±0.35</td> <td colspan="2"></td> </tr> <tr> <td>.XX</td> <td>±0.25</td> <td colspan="2"></td> </tr> <tr> <td>.XXX</td> <td>±0.15</td> <td colspan="2"></td> </tr> <tr> <td>X.'</td> <td>±2'</td> <td colspan="2"></td> </tr> <tr> <td colspan="4">PROJECT</td> </tr> <tr> <td colspan="4"> </td> </tr> </table>				GENERAL TOLERANCE				.X	±0.35			.XX	±0.25			.XXX	±0.15			X.'	±2'			PROJECT								TITLE 2.50mm WF ASSY right-angle SMT
GENERAL TOLERANCE																																										
.X	±0.35																																									
.XX	±0.25																																									
.XXX	±0.15																																									
X.'	±2'																																									
PROJECT																																										
20210415	B	EN120210415001	Add the Planting Code GW01	Cai Zhao	John Yang	APPROVAL	CHECK	DRAWN	DATE	<table border="1"> <tr> <td>UNIT</td> <td>SCALE</td> <td>SHEET</td> <td>REV</td> <td>NUMBER</td> </tr> <tr> <td>mm</td> <td>1:1</td> <td>2/2</td> <td>B2</td> <td>CD</td> </tr> </table>					UNIT	SCALE	SHEET	REV	NUMBER	mm	1:1	2/2	B2	CD																		
UNIT	SCALE	SHEET	REV	NUMBER																																						
mm	1:1	2/2	B2	CD																																						
DATE	REV	ECN NO.	DESCRIPTION	MODIFY	APPROVAL	Jack Zhang	Larry Yang	Kale Lin	2021/03/12																																	