

RoHS

This products can apply to the SESO Doc NO. QA-3-04-005 of Environmental&Material Management Rules

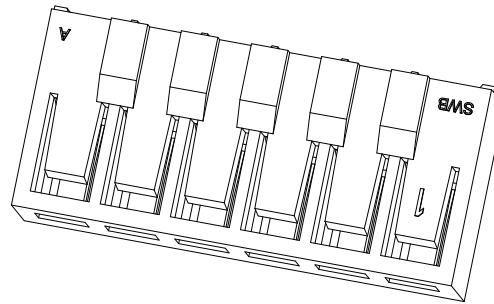

- Specifications :
- Voltage rating: 250V AC / DC
 - Current rating: 3A AC / DC
 - Withstanding voltage: 800V AC/minute
 - Temperature range: -40°C~+105°C
 - Insulation resistance:≥1000MΩ
 - Suitable SESO Terminal:9026TXV

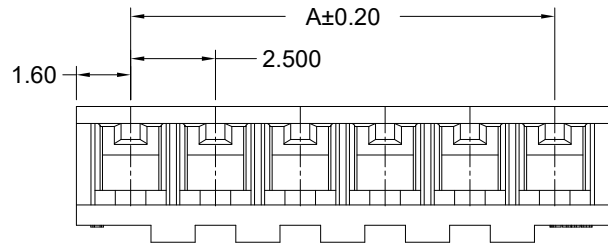
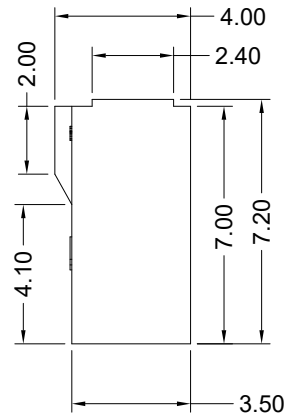
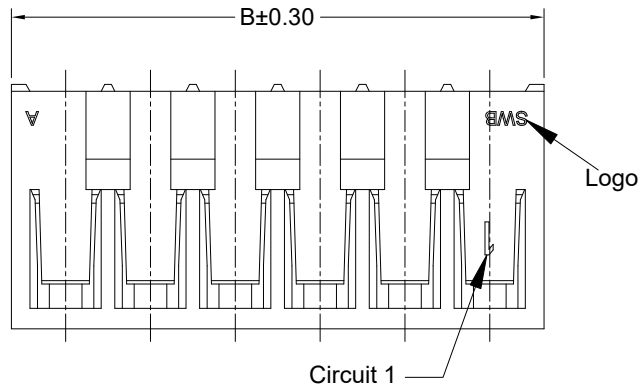

9026 H V-XX X-N0 NC

① ② ③ ④ ⑤ ⑥ ⑦

- ① Series No.
- ② Category: H-HSG
- ③ Connector type: V-180°
- ④ Row No.-Pin No per row: XX-02P~15P
- ⑤ Special No.:
- ⑥ Material: N0-PA66 UL 94V-0
- ⑦ Color: NC-Natural Color

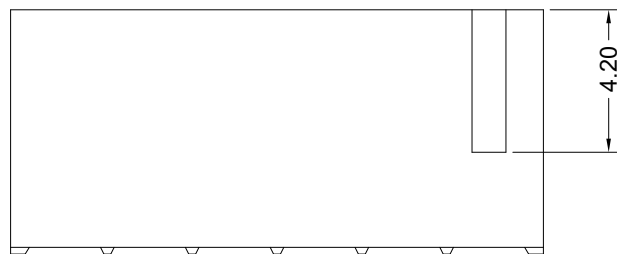
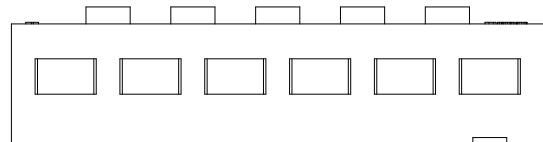

Poles	Dimensions (mm)		Poles	Dimensions(mm)	
	A	B		A	B
02	2.50	5.70	10	22.50	25.70
03	5.00	8.20	11	25.00	28.20
04	7.50	10.70	12	27.50	30.70
05	10.00	13.20	13	30.00	33.20
06	12.50	15.70	14	32.50	35.70
07	15.00	18.20	15	35.00	38.20
08	17.50	20.70			
09	20.00	23.20			

					GENERAL TOLERANCE				PART NO.					
					.X ±0.30				9026HV-XX-N0NC					
					.XX ±0.20				TITLE					
					.XXX ±0.10				2.50mm Crimp Style Connectors					
					X.° ±2°				UNIT SCALE SHEET REV NUMBER					
2023/8/17	A1	/	Update Drawing Frame	Zhou	Larry	APPROVAL	CHECK	DRAWN	DATE	mm	1:1	1/1	A1	A-000
DATE	REV	ECN NO.	DESCRIPTION	MODIFY	APPROVAL	PROJECT	Robing	/	Zeng	2018/08/16				

SMS 东莞市思索技术股份有限公司
Dongguan SESO Technology Co.,Ltd.

RoHS

This products can apply to the SESO Doc NO. QA-3-04-005 of Environmental&Material Management Rules

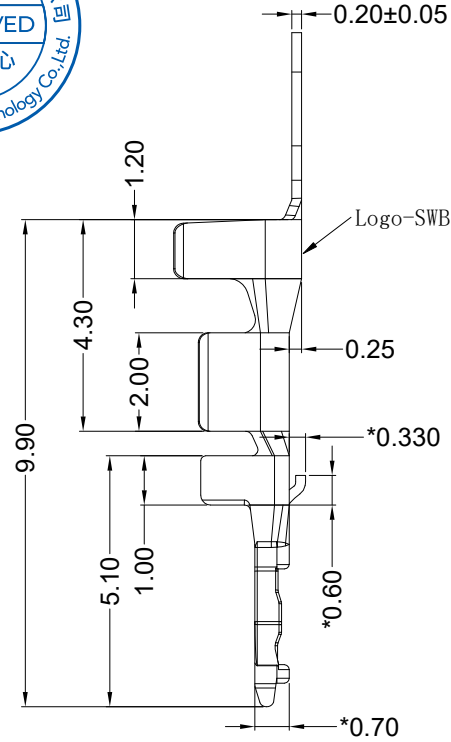
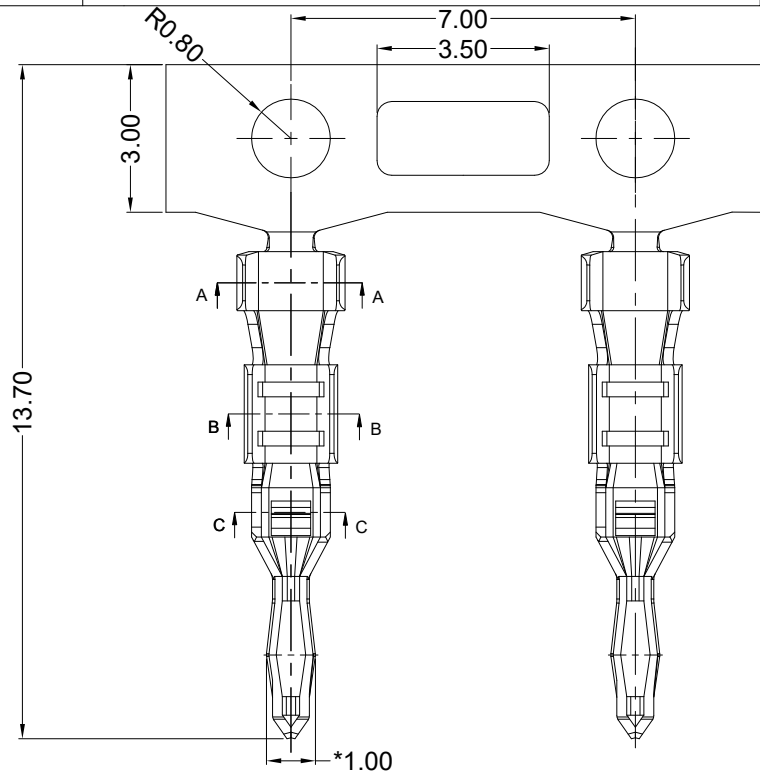

- Specifications :
- Voltage rating: 250V AC / DC
 - Current rating: 3A AC / DC
 - Withstanding voltage: 800V AC/minute
 - Temperature range: -40°C~+105°C
 - Insulation resistance: ≥1000MΩ
 - Wire Size: AWG#20~26(0.5~0.13m²)
 - Insulation O.D.: 1.50mm (Max)
 - Used In SESO Housing: 9026HV

9026 T X V-X SN X
① ② ③ ④ ⑤ ⑥ ⑦

- ① Series Number
 - ② Category: T-terminal
 - ③ Hape: L-Low Feet ; H-High Feet
 - ④ Hape: V-Straight 180°
 - ⑤ Material: B-Brass ; P-Phosphor bronze
 - ⑥ Plating style: SN-Bright tin plating
 - ⑦ Plating method: Blank-Stamping before plating
- Mold No./Mark/Special No. :

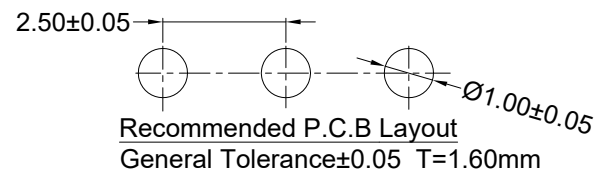
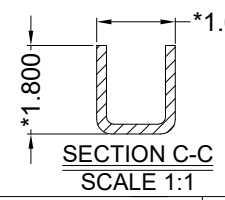
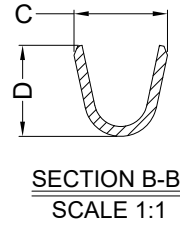
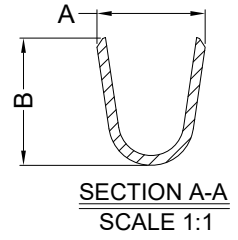
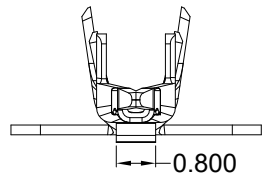

9026THV-XSN	AWG#20~22 0.50~0.35m ²	1.50mm (Max)	2.20	2.60	1.90	1.85
9026TLV-XSN	AWG#24~26 0.22~0.13m ²	1.30mm (Max)	2.20	2.60	1.30	1.40
P/N	Wire Range	Insulation O.D.	DIM a	DIM b	DIM c	DIM d

2023/8/17	A1	/	Update Drawing Frame	Zhou	Larry
DATE	REV	ECN NO.	DESCRIPTION	MODIFY	APPROVAL

GENERAL TOLERANCE				东莞市思索技术股份有限公司 Dongguan SESO Technology Co.,Ltd.				PART NO. 9026TXV-XSN							
.X	±0.30	APPROVAL						CHECK	DRAWN	DATE	TITLE 2.50mm Crimp Style Connectors				
.XX	±0.20	Robing						/	Zeng	2021/11/22	UNIT	SCALE	SHEET	REV	NUMBER
.XXX	±0.10	PROJECT									mm	1:1	1/1	A1	A-000
X°	±2°														