

RoHS

本产品符合我司QA-3-04-005  
环境管理物质标准规范

包装图

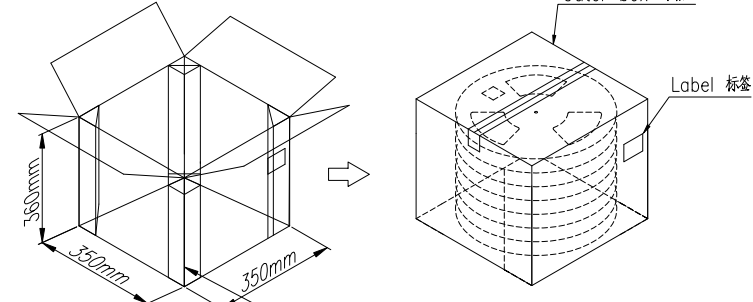
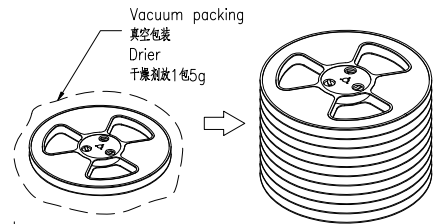
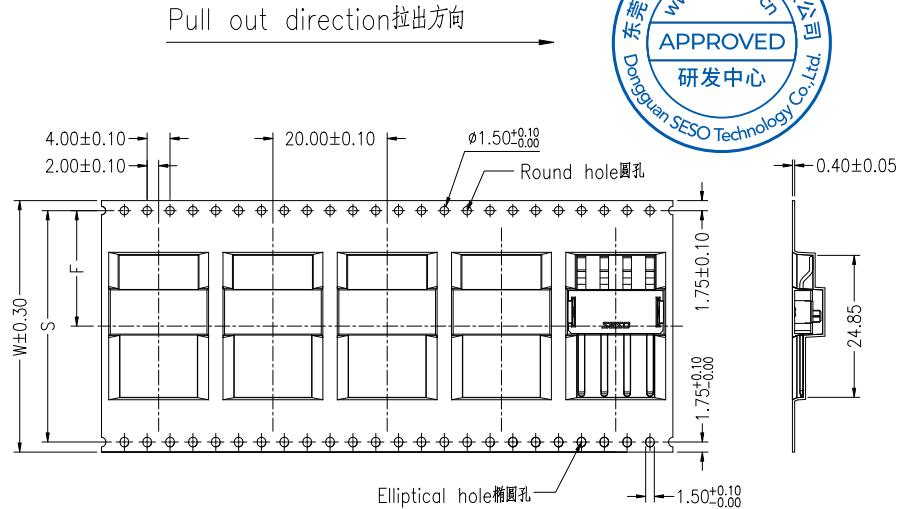
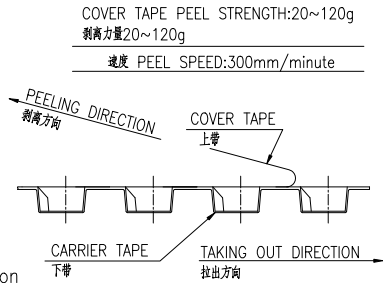
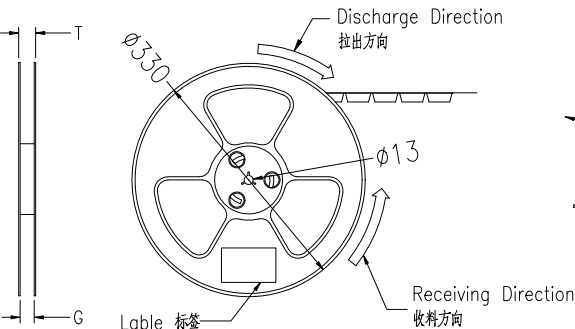
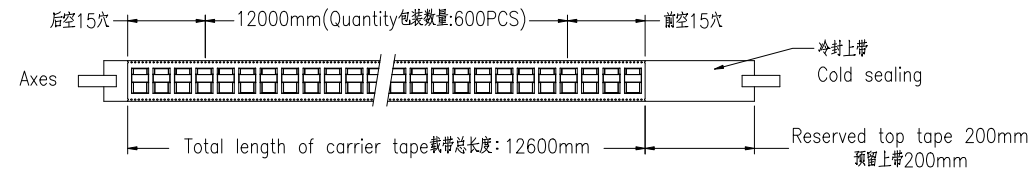

- Note:
- Carrier Camber Is Within 1mm In 100mm ; 带长100mm内容许弯曲度1mm
  - 10 Sprocket Hole Pitch Cumulative Tolerance±0.2MM ; 圆孔十个孔距累积允许公差为±0.2mm
  - Carrier tape material: PS,thickness=0.40±0.05mm,color:lucency.  
载带材质:PS,厚度=0.40±0.05mm,颜色:透明色.
  - Bracer material: PS,thickness=0.40±0.05mm,color:lucency.  
保护带材质:PS,厚度=0.40±0.05mm,颜色:透明色.
  - Cover tape material: PET,Cold sealing.  
上带材质:PET,冷封.
  - Reel material: PS,color:blue. 卷盘材质:PS,颜色:蓝色.
  - Carton material 纸箱材质:K=K; Carton Thickness 纸箱厚度: 6~7mm

Applicable Product No. 适用产品料号	W	S	F	T	G	REEL PCS/卷	CARTON 卷/箱	CARTON PCS/箱
4009WRS-04P-9TSWBR	44	40.40	20.20	48.5	44.5	600	7	4200

20231213	A0	/	Initial release	/	Larry Yang
日期	版次	变更编号	变更内容说明	变更人	核准

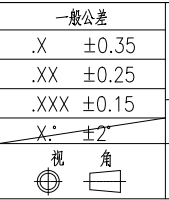

**SMS** 东莞市思索技术股份有限公司  
Dongguan SESO Technology Co.,Ltd.

核准	审查	制作	日期
杨蒙	杨梅	滕敏	2023/12/13

料号: PK-4009WRS-04P-9TSWBR				
名称: 4.00 mm Pin Header Connectors Packing				
单位	比例	页次	版本	编号
mm	1:1	1/1	A0	A-213