

RoHS

This products can apply to the SWB Doc NO. QA-3-04-005 of Environmental&Material Management Rules

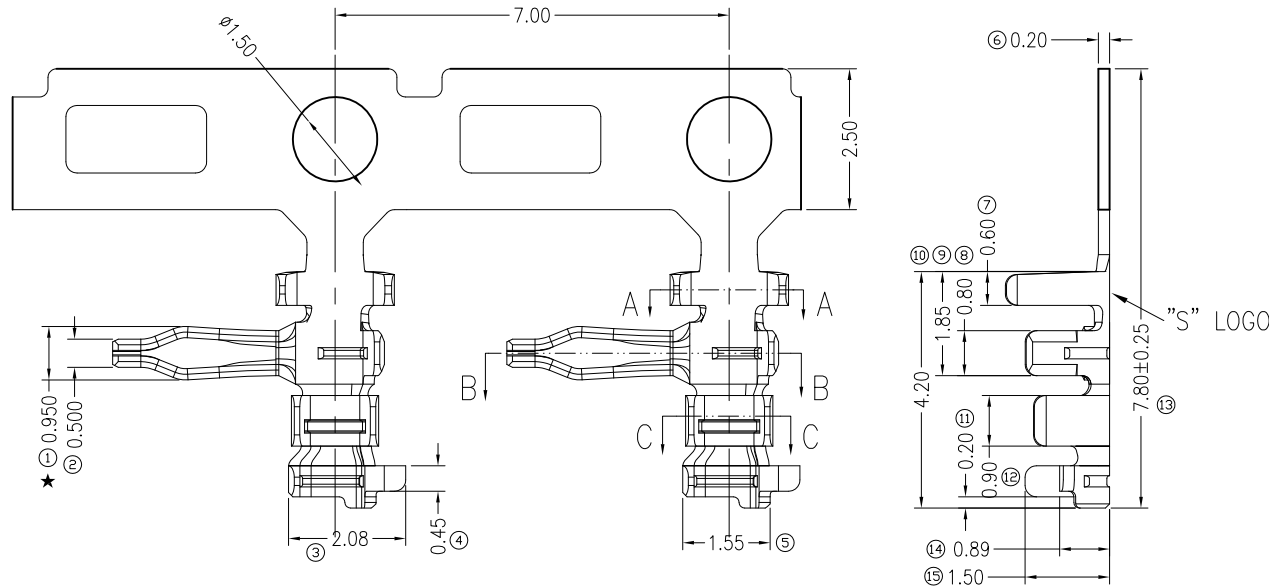

- Specifications :
- Voltage rating: 250V AC / DC
 - Current rating: 2A AC / DC
 - Withstanding voltage: 800V AC/minute
 - Temperature range: -40°C~+125°C
 - Insulation resistance: ≥1000MΩ
 - Used In SWB Housing: 9021HR
 - "★" Critical dimension

9021 T R-X SN1 X-X
① ② ③ ④ ⑤ ⑥ ⑦

- ① Series Number
- ② Category: T-terminal
- ③ Connector type: R-Right Angle 90°
- ④ Material: B-Brass;P-Phosphor Bronze
- ⑤ Plating code: SN1-Bright tin plating
- ⑥ Plating method: Blank-Stamping before plating
- ⑦ Mold No./Mark/Special No. :
Blank-Ordinary; H-High feet

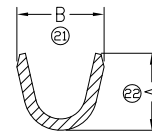
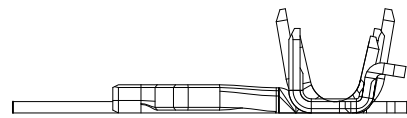

SECTION: C-C
SCALE: 1:1

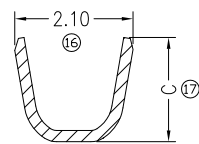

SECTION: A-A
SCALE: 1:1

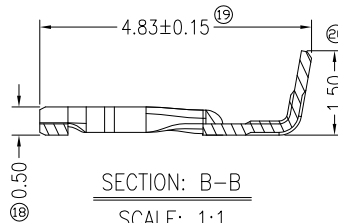

SECTION: B-B
SCALE: 1:1

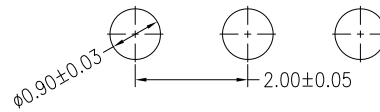

RECOMMENDED P.C.B LAYOUT
(Thickness=1.60mm)

9021TR-XSN1-H	AWG#22~24 0.35~0.22mm ²	1.40mm (Max)	1.60	1.70	2.00
9021TR-XSN1	AWG#24~26 0.22~0.13mm ²	1.30mm (Max)	1.35	1.55	1.85
PART NO	Wire Size	Insulation ϕ O.D.	DIM A	DIM B	DIM C

					GENERAL TOLERANCE .X ± 0.35 .XX ± 0.25 .XXX ± 0.15 X. $^{\circ}$ $\pm 2^{\circ}$				东莞市思索连接器有限公司 SWB CONNECTORS CO.,LTD				PART NO. 9021TR-XSN1-X																
					PROJECT 				APPROVAL Larry Yang				CHECK /				DRAWN Wangcheng				DATE 2022/01/21				TITLE 2.00mm Crimp Style Connectors				
DATE	REV	ECN NO	DESCRIPTION	MODIFY	APPROVAL						UNIT	SCALE	SHEET	REV	NUMBER														
1											mm	1:1	1/1	A0	A-000														

RoHS

This products can apply to the SWB Doc NO. QA-3-04-005 of Environmental&Material Management Rules

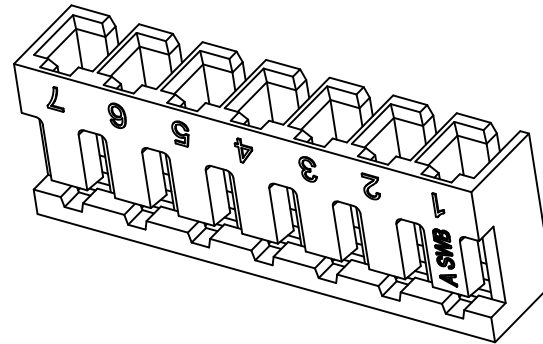
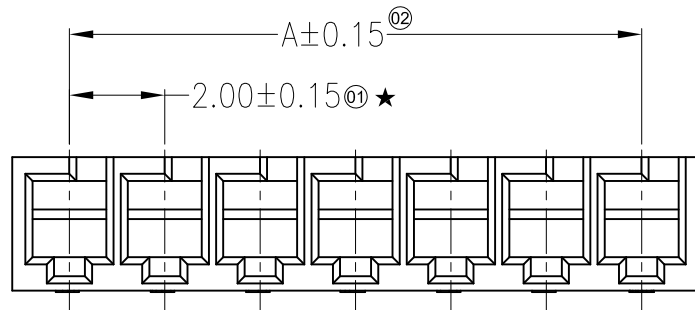

Specifications :

- Voltage rating: 250V AC / DC
- Current rating: 2A AC / DC
- Withstanding voltage: 800V AC/minute
- Temperature range: -40°C~+125°C
- Insulation resistance: ≥1000MΩ
- Suitable SWB Terminal: 9021TR
- "★" Critical dimension

9021 H R - XX X - NO XX NC
 ① ② ③ ④ ⑤ ⑥ ⑦ ⑧

- ① Series No.
- ② Category: H-HSG
- ③ Appearance type: R-Right Angle 90°
- ④ Row No.-Pin No.: XX-02P~16P
- ⑤ Special No.: Blank-Ordinary
- ⑥ Material: NO-PA66 UL 94V-0
- ⑦ HF-Halogen Free
- ⑧ Color: NC-Natural Color

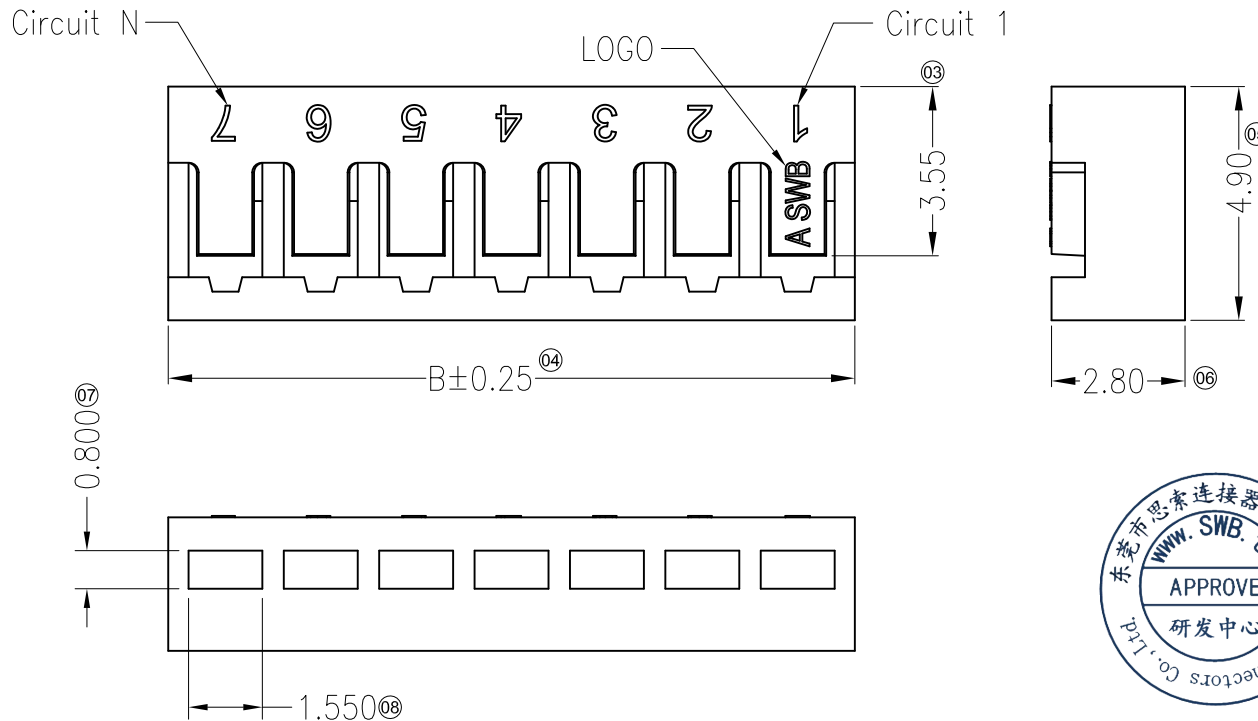

Poles	Dimensions (mm)		Poles	Dimensions (mm)	
	A	B		A	B
02	2.00	4.40	10	18.00	20.40
03	4.00	6.40	11	20.00	22.40
04	6.00	8.40	12	22.00	24.40
05	8.00	10.40	13	24.00	26.40
06	10.00	12.40	14	26.00	28.40
07	12.00	14.40	15	28.00	30.40
08	14.00	16.40	16	30.00	32.40
09	16.00	18.40			



					GENERAL TOLERANCE .X ±0.35 .XX ±0.25 .XXX ±0.15 X.° ±2° PROJECT 				东莞市思索连接器有限公司 SWB CONNECTORS CO.,LTD APPROVAL CHECK DRAWN DATE Larry Yang / Wangcheng 2022/02/15				PART NO. 9021HR-XX-NOXXNC TITLE 2.00mm Crimp Style Connectors UNIT SCALE SHEET REV NUMBER mm 1:1 1/1 A0 A-000				
DATE	REV	ECN NO	DESCRIPTION	MODIFY	APPROVAL	PROJECT	APPROVAL	CHECK	DRAWN	DATE	UNIT	SCALE	SHEET	REV	NUMBER		
1											mm	1:1	1/1	A0	A-000		